

Ci250RRM-THX Architectural Speaker

KEF's First Architectural Speaker with MAT™

A revolutionary architectural speaker in the KEF Extreme Home Theatre line-up, Ci250RRM-THX is KEF's first three-way coaxial architectural speaker model with innovative technologies where the KEF engineering team in Maidstone, UK, has pushed the technological boundaries to create the best possible sound.

Featuring innovative technologies including 12th generation Uni-Q driver array with Metamaterial Absorption Technology¹ (MAT), patent-pending Cavity Radiation Control and Low Diffraction LF Aperture, Ci250RRM-THX is a truly revolutionary coaxial three-way architectural speaker that delivers immersive, high-fidelity soundstage with unmatched sonic excellence for large home theatres and living rooms.

12th Generation Uni-Q® Driver Array With MAT™

The Ci250RRM-THX is the first architectural speaker that benefits from our acoustic innovation: Metamaterial Absorption Technology (MAT). MAT is a highly complex maze-like structure that absorbs 99% of the unwanted sound from the rear of the tweeter, delivering a more crisp, natural treble performance.

Uni-Q technology is the building block of KEF signature sound. Designed to perform at its best in Ci250RRM-THX, the remarkable 12th generation Uni-Q driver array acts as a single point source, dispersing sound more evenly allowing everyone sitting at different spots in the room to experience the same natural detailed sound.

Patent-pending Cavity Radiation Control

The patent-pending technology 'Cavity Radiation Control' has solved the midrange issues found in typical three-way coaxial loudspeakers. Its unique open-back midrange with acoustically absorptive foam design eliminates midrange issues including frequency response dips of up to 30dB in magnitude, which is equivalent to 99.9% of reduced SPL. With Cavity Radiation Control, Ci250RRM-THX delivers the highest midrange acoustic realism among three-way coaxial loudspeakers to date.

Low Diffraction LF Aperture

Ci250RRM-THX features Low Diffraction LF Aperture, a carefully profiled, smoothed housing design with an outer acoustically absorptive foam ring that reduces resonance and diffraction. As a result, it delivers exceptional MF/HF performance while preserving a tremendous bass output.

Powerful, high-fidelity sound

As part of the Extreme Home Theatre line-up within KEF Architectural Speakers, Ci250RRM-THX is engineered to deliver powerful, room-filling, high-fidelity sound for the most discerning music and movie lovers. Featuring a 250mm (10 in.) LF driver, Ci250RRM-THX delivers deep, room-filling bass down to 28Hz. Together with the 100mm (4 in.) Uni-Q driver array with MAT, Ci250RRM-THX delivers powerful, high-fidelity sound with maximum SPL of 111dB.

Designed to perform

Engineered to be structurally robust with a premium aesthetic, the bespoke Ultra-Thin Bezel (UTB) offers the slimmest visible rim around the speaker while casting virtually no shadow. The paintable UTB and magnetic grille ensures the speaker seamlessly blends into the environment. With a well-considered mechanical design, Ci250RRM-THX ensures ease of installation with minimum fuss.

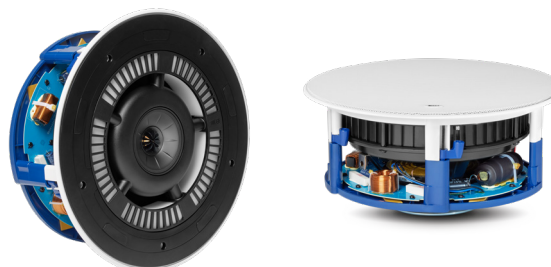
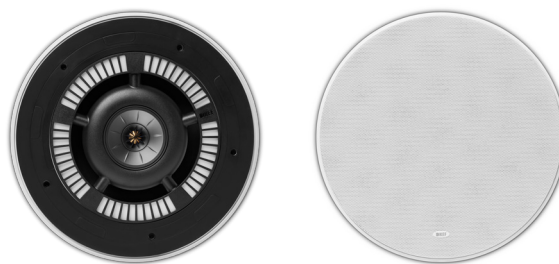

THX® Certified Ultra

Ci250RRM-THX delivers ultra-high performance with true theatre sound quality for large home theatres and living rooms and it is certified to THX® Ultra.

IP64 Certified

Ci250RRM-THX is IP64 certified, which means as well as being impregnable by dust, it is also splash proof. The speaker passed official IEC testing to ensure that splashing water would have no harmful effects on assembly components.

Hide your speakers, not your sound

'Hide your speakers, not your sound' is the concept behind every KEF architectural speaker. Like all other models in the category, Ci250RRM-THX is designed to be discreet in appearance and engineered with best-in-class acoustic performance, delivering an immersive soundscape while the speakers blend into the interior.

Specifications

Model		Ci250RRM-THX
Series		Ci-R Series
Nominal impedance		8Ω
Sensitivity (2.83V/1m)		89dB
Frequency response (±6dB) open-backed		28Hz - 20kHz
Frequency range (-10dB)		20Hz - 45kHz
Nominal coverage		120°
Max SPL		111dB
Crossover frequency		540Hz, 2.6kHz
Drive units	LF	250mm (10in.)
	MF	100mm (4in.) Uni-Q
	HF	19mm (0.75in.) vented aluminium dome with Metamaterial Absorption Technology ¹
Recommended amplifier power		50 - 250W
Recommended high-pass filter (Hz)		30 - 60Hz
Product external dimensions	Diameter Ø	346mm (13.62in.)
	Depth	175mm (6.89in.)
Cut-out dimensions	Diameter Ø	300mm (11.81in.)
Net Weight		6kg (13.2lbs)
Mounting depth from surface		168mm (6.62in.)
Optional rough in frame		-
Ideal rear volume		150L
Minimum rear volume		80L
THX certification		THX® Certified Ultra
Safety and Regulatory Compliance		IP64
Ceiling thickness (Maximum)		30mm (1.18in.)
Ceiling thickness (Minimum)		6mm (0.24in.)

¹ Metamaterial Absorption Technology is a joint development with Acoustic Metamaterials Group.

Visit [KEF.COM](https://www.kef.com) for more about KEF and its products.

KEF reserves the right, in line with continuing research and development, to amend or change specifications. E&OE. The Ci speakers that utilise THX in the model name have undergone and passed certified THX approval.

Directivity Index

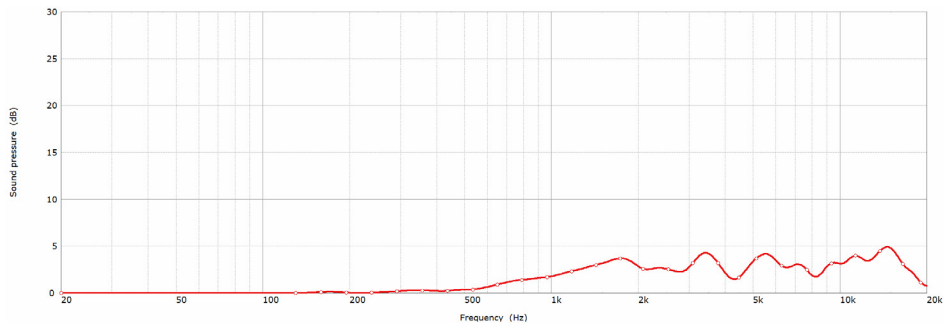

Beamwidth -3dB

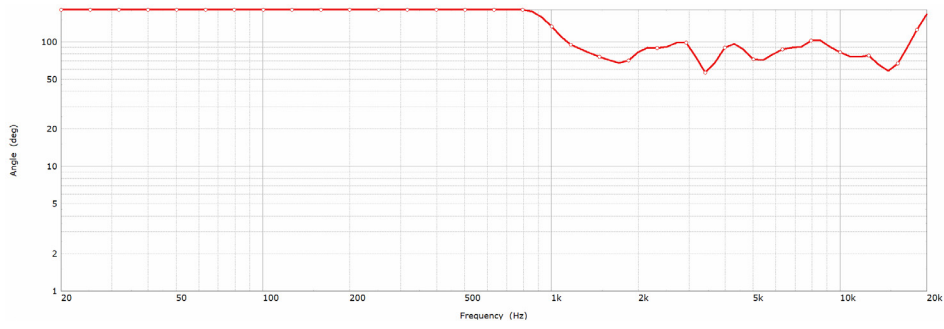

Beamwidth -6dB

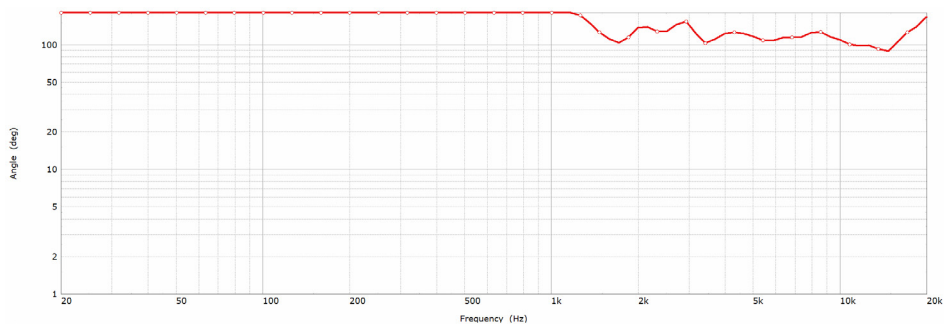

Impedance

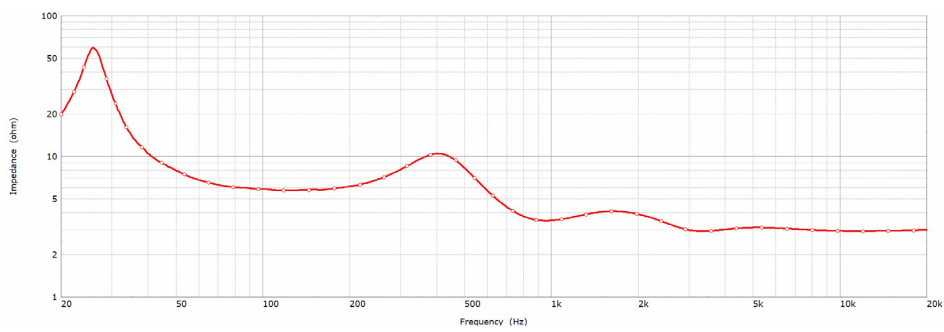

Sensitivity (2.83V/1m)

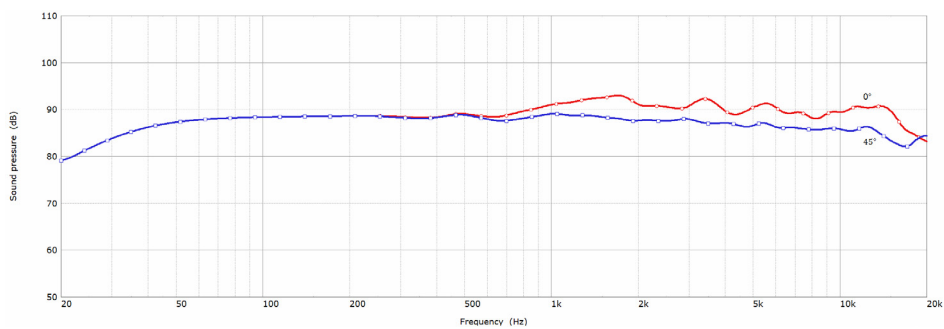

Polar Responses

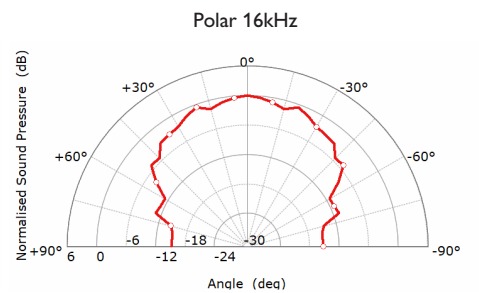
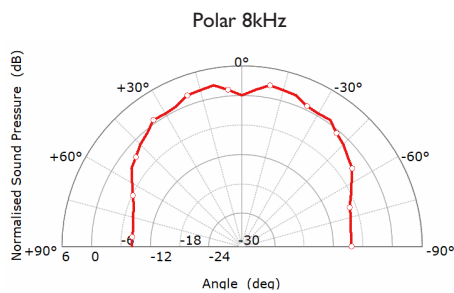
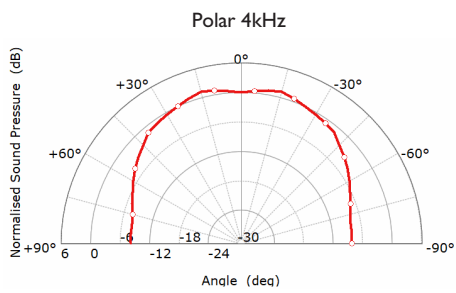
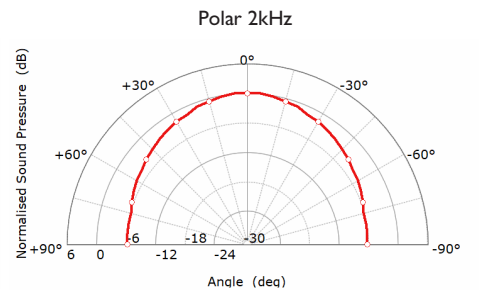
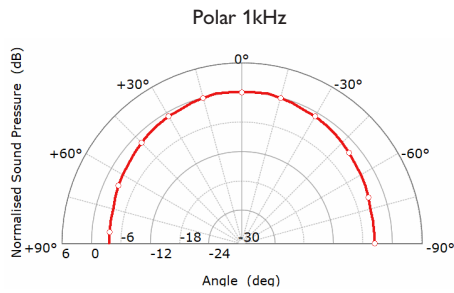
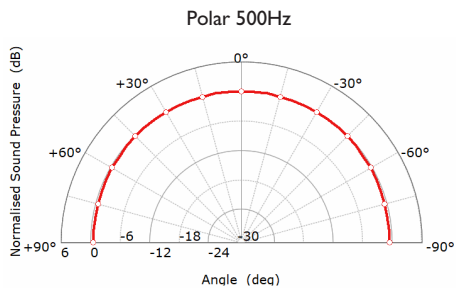
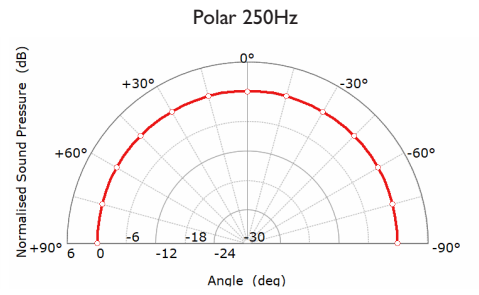
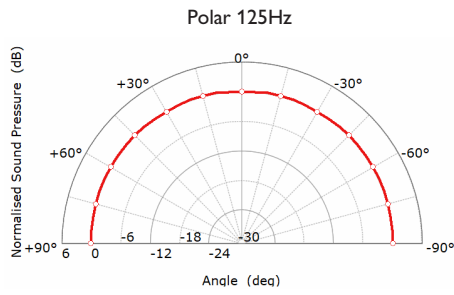
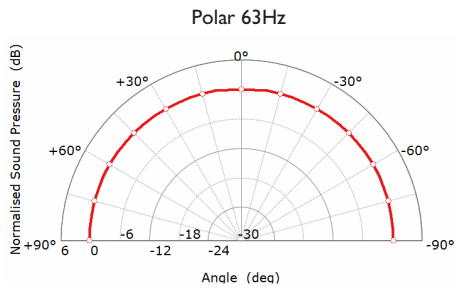

Mechanical Diagrams

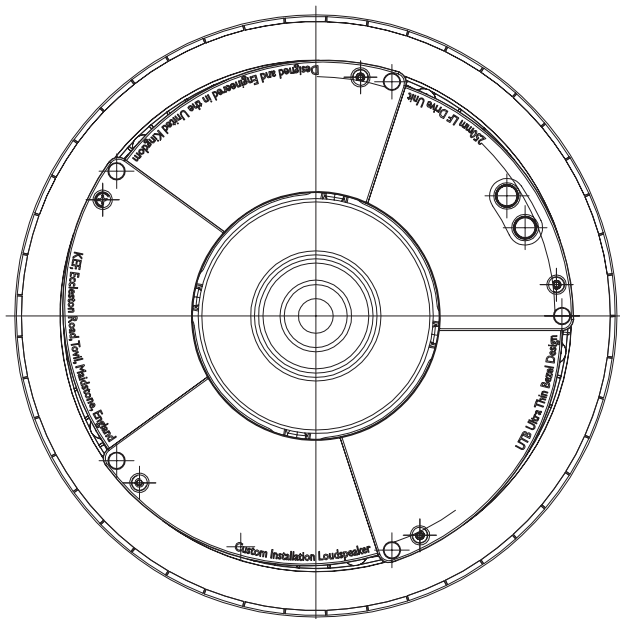
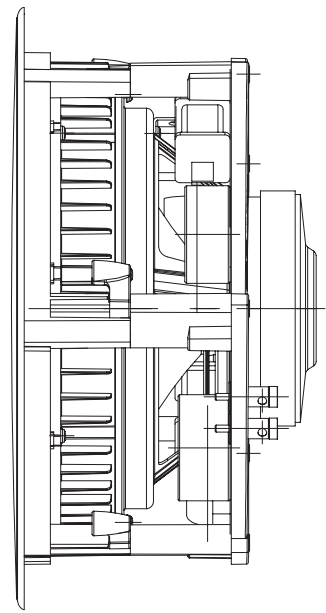
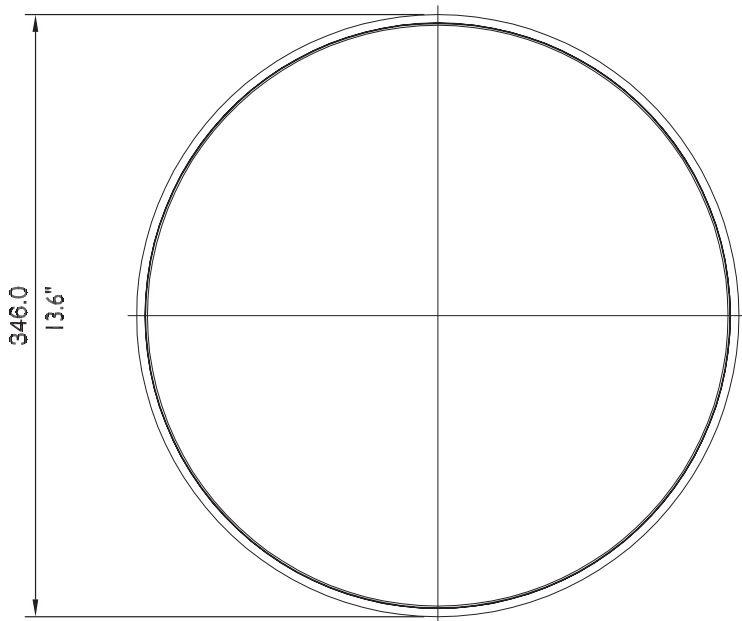
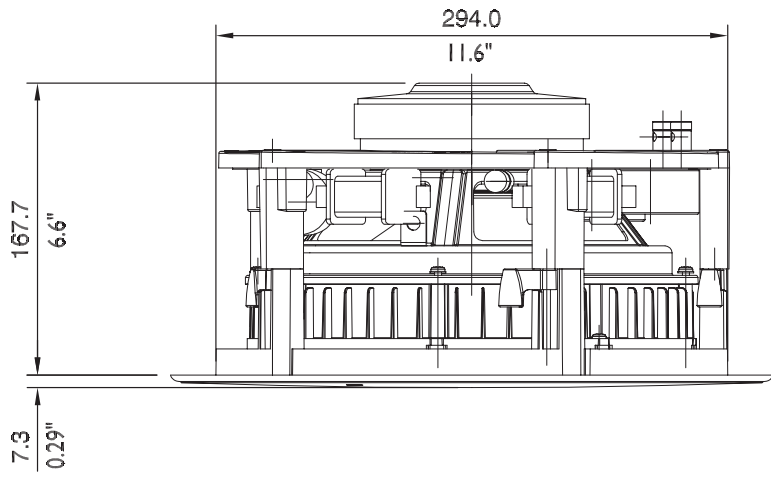

Dimensions in mm (inches)

KEF reserves the right, in line with continuing research and development, to amend or change specifications. E&OE.