

User Manual

LS50 Wireless II

Table of Contents

| | |
|---|-----------|
| 1. Introduction | 5 |
| 2. General Information | 6 |
| 2.1 Reading and Storing the User Manual | 6 |
| 2.2 Signal Symbol/Word Definitions | 6 |
| 3. In the Box and Unpacking | 7 |
| 4. Setting Up LS50 Wireless II | 8 |
| 4.1 Selecting an Appropriate Router | 8 |
| 4.2 Connecting to Power | 9 |
| 4.3 Onboarding | 10 |
| 4.3.1 Installing the KEF Connect App | 10 |
| 4.3.2 Using iOS Devices | 11 |
| 4.3.3 Using Android Devices with Google Play Service | 12 |
| 4.3.4 Using Android Devices without Google Play Service | 14 |
| 4.4 Speaker Placement and Connection | 16 |
| 5. Connection and Control Interface | 17 |
| 5.1 Front Panel | 17 |
| 5.2 Back Panel | 18 |
| 5.3 Bottom Panel | 20 |
| 5.4 Top Panel | 21 |
| 5.5 Remote Control | 22 |
| 5.6 KEF Connect App | 23 |
| 6. Wi-Fi Streaming | 24 |
| 6.1 Wireless Streaming Protocols | 24 |
| 6.1.1 AirPlay 2 | 24 |
| 6.1.2 Chromecast | 25 |
| 6.1.3 ROON Ready (coming soon) | 26 |
| 6.1.4 Music Streaming Apps Native Protocols | 27 |
| 6.1.4.1 Spotify Connect | 27 |
| 6.1.4.2 QPlay | 28 |
| 6.1.4.3 TIDAL Connect | 29 |
| 6.1.5 KEF Connect App Streaming | 30 |
| 6.1.5.1 Amazon Music | 30 |
| 6.1.5.2 Deezer | 30 |
| 6.1.5.3 Qobuz | 30 |
| 6.1.5.4 Spotify | 30 |
| 6.1.5.5 TIDAL | 31 |
| 6.1.5.6 Internet Radio | 31 |
| 6.1.5.7 Podcast | 31 |
| 6.1.6 UPnP Playback | 31 |
| 6.2 Tips on Choosing Streaming Protocols | 32 |
| 7. Multi-Room Streaming | 33 |
| 7.1 AirPlay 2 | 33 |
| 7.2 Chromecast | 33 |
| 7.3 ROON | 35 |

| | |
|---|-----------|
| 8. Voice Control Over Mobile Device | 36 |
| 8.1 Siri..... | 36 |
| 8.2 Google Assistant..... | 36 |
| 9. Playback with Bluetooth | 37 |
| 9.1 Selecting Bluetooth Mode..... | 37 |
| 9.2 Bluetooth Pairing..... | 37 |
| 9.3 Playback Controls..... | 38 |
| 10. Playback with HDMI eARC input..... | 39 |
| 10.1 HDMI Cable Connection..... | 39 |
| 10.2 Selecting TV Mode..... | 40 |
| 10.3 Playback Controls..... | 40 |
| 11. Playback with Optical Input | 41 |
| 11.1 Optical Cable Connection | 41 |
| 11.2 Selecting Optical Mode..... | 42 |
| 11.3 Playback Controls..... | 42 |
| 12. Playback with Coaxial Input..... | 43 |
| 12.1 Coaxial Cable Connection..... | 43 |
| 12.2 Selecting Coaxial Mode..... | 44 |
| 12.3 Playback Controls..... | 44 |
| 13. Playback with Auxiliary Input | 45 |
| 13.1 Auxiliary Cable Connection..... | 45 |
| 13.2 Selecting Auxiliary Mode..... | 46 |
| 13.3 Playback Controls..... | 46 |
| 14. Using KEF Connect App..... | 47 |
| 14.1 Home..... | 47 |
| 14.1.1 Overview | 47 |
| 14.1.2 Editing the Home Screen (coming soon)..... | 48 |
| 14.2 Remote Control..... | 48 |
| 14.3 Music Content..... | 49 |
| 14.3.1 Playing Music from Music Streaming Services..... | 50 |
| 14.3.1.1 Amazon Music..... | 50 |
| 14.3.1.2 Deezer..... | 51 |
| 14.3.1.3 Qobuz..... | 52 |
| 14.3.1.4 Spotify..... | 53 |
| 14.3.1.5 Tidal..... | 53 |
| 14.3.1.6 Internet Radio..... | 54 |
| 14.3.1.7 Podcast..... | 54 |
| 14.3.2 Playback Controls..... | 55 |
| 14.3.2.1 Playback Screen | 55 |
| 14.3.2.2 Search..... | 55 |
| 14.3.2.3 Favourites..... | 56 |
| 14.3.2.4 Queue (coming soon)..... | 57 |
| 14.3.2.5 Playlists..... | 59 |
| 14.4 Equalisations..... | 61 |
| 14.4.1 Normal Mode (coming soon)..... | 61 |
| 14.4.2 Expert Mode..... | 63 |
| 14.4.3 Selecting a Sound Profile (coming soon) | 66 |

| | | |
|------------|--|-----------|
| 14.4.4 | Renaming a Sound Profile | 66 |
| 14.4.5 | Deleting a Sound Profile | 67 |
| 14.5 | Profile..... | 68 |
| 14.6 | Choosing Your Speaker | 69 |
| 14.6.1 | My Speaker and Speakers Nearby..... | 69 |
| 14.6.2 | Speaker Info | 70 |
| 14.7 | Speaker Preferences..... | 71 |
| 14.7.1 | Power Saver – Standby Mode | 71 |
| 14.7.2 | Power Saver – Second Wake-Up Source..... | 71 |
| 14.7.3 | Do Not Disturb – Start Up Tone (coming soon)..... | 71 |
| 14.7.4 | Do Not Disturb – Top Panel Lock..... | 72 |
| 14.7.5 | Speaker System Options – Cable Mode | 72 |
| 14.7.6 | Speaker System Options – Inverse L/R Speakers..... | 72 |
| 14.8 | Volume..... | 73 |
| 14.8.1 | Volume Display Setting..... | 73 |
| 14.8.2 | Hardware Volume..... | 74 |
| 14.8.3 | Speaker Volume Sensitivity..... | 74 |
| 14.8.4 | Maximum Volume..... | 74 |
| 14.8.5 | Balance Control | 74 |
| 14.9 | Firmware Upgrade..... | 75 |
| 14.9.1 | Automatic Firmware Update after Onboarding..... | 75 |
| 14.9.2 | Automatic Firmware Check..... | 75 |
| 14.9.3 | Manual Firmware Update..... | 76 |
| 14.10 | Application..... | 77 |
| 14.10.1 | Streaming Settings – Audio Quality..... | 77 |
| 14.10.2 | Theme Settings – Dark Theme | 77 |
| 14.10.3 | Theme Settings – Reset Home Screen | 77 |
| 14.10.4 | Analytics – Improve App/Speaker | 78 |
| 14.11 | Support..... | 79 |
| 15. | Cleaning and Maintenance | 80 |
| 16. | Disposal | 81 |
| 16.1 | Disposing of the Packaging..... | 81 |
| 16.2 | Disposing of the Speakers..... | 81 |
| 16.3 | Disposing of the Battery | 81 |
| 17. | FAQ and Troubleshooting | 82 |
| 17.1 | Set-up | 82 |
| 17.2 | Playback and Streaming | 84 |
| 17.3 | Troubleshooting | 86 |
| 17.4 | LED Indicators..... | 89 |
| 18. | Appendix..... | 92 |
| 18.1 | Specifications..... | 92 |
| 18.2 | Explanation of symbols..... | 95 |
| 18.2.1 | Warning Symbols..... | 95 |
| 18.2.2 | Regional Symbols | 95 |
| 18.3 | IR Command Codes..... | 97 |

1. Introduction

Thank you for choosing KEF wireless speaker system – LS50 Wireless II.

Innovation is what sets KEF apart from its competitors. For over 50 years KEF has been at the forefront of loudspeaker research and development, designing class-leading speakers that have dealt with the challenges of reproducing the latest musical formats, and reproducing them to the highest possible quality. This legacy continues today with the LS50 Wireless II, our compact, yet powerful speaker system for the digital music era.

The new KEF LS50 Wireless II is a fully active wireless stereo system that delivers pristine, KEF sound coupled with instinctive usability and high-performance wireless capability. Completely re-engineered and capable of playing any source seamlessly, LS50 Wireless II is the only hi-fi system you will ever need, contained within two perfectly proportioned, precision-made cabinets.

Please read and follow this user manual carefully before using the speaker system.

2. General Information

2.1 Reading and Storing the User Manual



This user manual accompanies the LS50 Wireless II speaker system (hereafter referred to as the “speakers”), and contains important information on setup and handling.

Before using your speakers, read this user manual and the safety information (as a separate booklet) carefully. This particularly applies to the safety information. Failure to do so may result in personal injury or damage to the speakers.

Retain the user manual and safety information for further use. Make sure to include the user manual and safety information when passing the speakers on to third parties.

2.2 Signal Symbol/Word Definitions

The following symbols and signal words are used in this user manual.



WARNING! This signal symbol/word designates a hazard with moderate risk, which may result in death or severe injury if not avoided.



NOTICE! This signal word warns of possible damage to property.



This signal word provides you with useful additional information on handling and use.

3. In the Box and Unpacking

NOTICE!

Risk of damage!

Using a sharp knife or other pointed object to open the packaging may damage the speakers.

- Be very careful when opening the packaging. Follow the instructions on the packaging to lift up the speakers from the sides to avoid damaging the Uni-Q drivers (speaker cones).

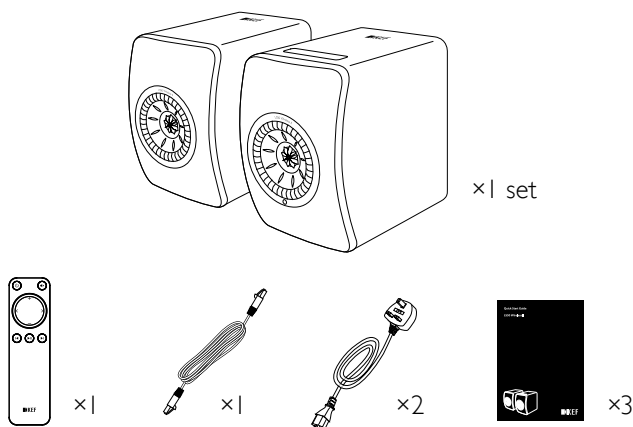

1. Take the speakers and accessories out of the packaging.
2. Remove the red protective stickers and tabs on the speakers.
3. Check to make sure that all parts are included, namely:
 - Speaker $\times 2$ (Primary Speaker $\times 1$, Secondary Speaker $\times 1$)
 - Remote control $\times 1$ (with 2 AAA batteries)
 - Inter-speaker cable $\times 1$ (length: 3 m)
 - Power cable $\times 2$ (length: 2 m, with country-specific power plugs)
 - Printed materials: Quick Start Guide, Safety Information and Warranty Information
4. Check whether the speakers or individual parts are damaged. If this is the case, do not use the speakers and contact your retailer.

4. Setting Up LS50 Wireless II

4.1 Selecting an Appropriate Router

The speakers must be “onboarded” to your personal Wi-Fi network (see chapter “[Onboarding](#)”) for the best sound quality, comprehensive control and to enjoy music streaming,

Technical Requirements of your Router

- Network standard: IEEE 802.11 a/b/g/n/ac, IPv4, IPv6,
- Frequency band: Dual-band 2.4 GHz / 5 GHz



- A 5 GHz Wi-Fi network is recommended for stable streaming, especially for hi-resolution music.
- **Connecting to a guest, office or public network:** Office, hotel, guest and public networks often feature additional security or authentication methods which may prevent the speakers from connecting. You may need the help of the network administrator to configure the network to allow full functionality if using these kinds of networks.

4.2 Connecting to Power

1. Connect the power cables into the AC input connectors (A) on the back panels of the Primary and Secondary Speakers.

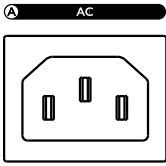

2. Connect the power plugs into the power sockets/outlets.

After successful power connections, the Wi-Fi icon on the top panel of the Primary Speaker will blink white and amber. The speakers are now ready to be “onboarded” to your personal Wi-Fi network through the KEF Connect App (see chapter “[Onboarding](#)”).

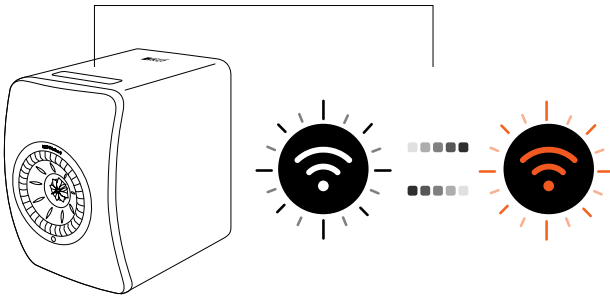

4.3 Onboarding

4.3.1 Installing the KEF Connect App

Install the KEF Connect App on your mobile device to get the speakers “onboarded” to your personal Wi-Fi network.

1. Search “KEF Connect” in the App Store or Google Play Store to download and install the KEF Connect App on your iOS* or Android** device.



2. Launch the KEF Connect App on your device and create a user account. You may log in with your existing Facebook, Google or Apple*** account, or create a new KEF account with your email address.

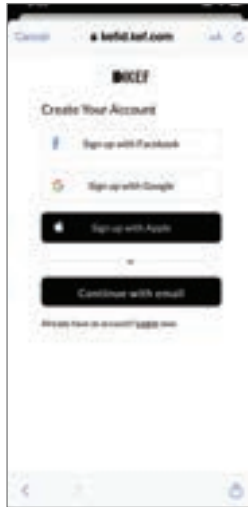

*Requires iOS 13 or above.

**Requires Android 8 or above.

***The use of an Apple account is only available on iOS devices.

4.3.2 Using iOS Devices

1. Make sure your mobile device is connected to the network you want to onboard your speaker to.
2. Launch and login to the KEF Connect App on your mobile device.
3. Select “LS50 Wireless II” under “Speakers nearby”.

The speakers with the warning sign () are not set up yet. Select the speakers with this warning mark to get them “onboarded”.

The speakers with the check mark () are ready for use. This icon will show for speakers already onboarded or directly connected to the network via a cable.

4. Select your local Wi-Fi network. Press “Next” to begin the onboarding process.

You may rename the speakers by tapping “Speaker name”.

5. The onboarding process will be done automatically. Tap “Done” when the process is completed.

[Step 3–5]

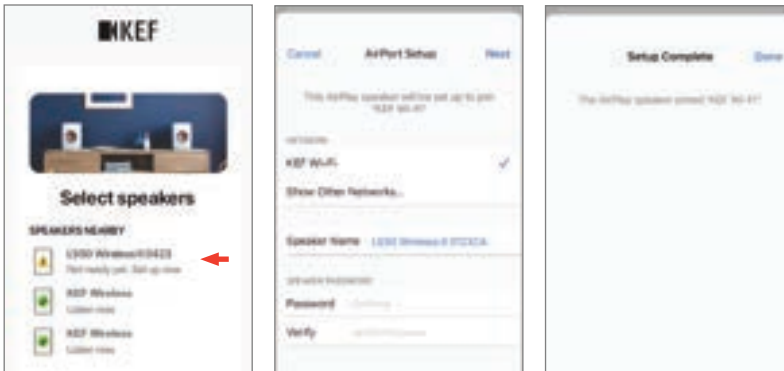

- The Wi-Fi icon on the top panel of the Primary Speaker is solid white when the speakers are successfully connected.

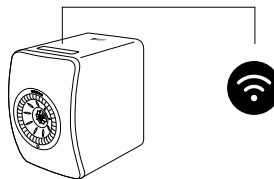

- After successful connection, you may be prompted if there is a new firmware update available. Follow the instructions in the KEF Connect App to complete the update process.

4.3.3 Using Android Devices with Google Play Service

1. Make sure your mobile device is connected to your local Wi-Fi network.
2. Launch and login to the KEF Connect App on your mobile device.
3. Allow the app to access your device's location when requested.
4. Select "LS50 Wireless II" under "Speakers nearby".

The speakers with the warning sign () are not set up yet.

The speakers with the check mark () are ready for use.

5. Tap "Open Google Home" to proceed. If your mobile device does not have Google Home, you will be prompted to download and install the app on your device.

[Step 3–5]

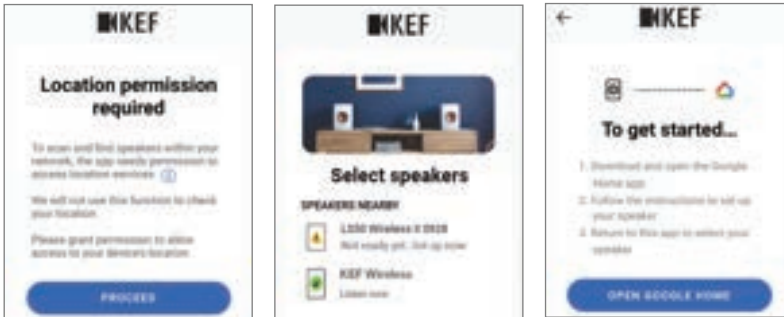

6. Tap "Set up LS50 Wireless II" at the top of the screen.
7. Tap "Add another home".
8. Create a nickname for the home and then tap "Next".

[Step 6–8]



Google Home will start to look for and connect to the speakers. Follow the instructions on the screen to assign a use location (e.g home) and connect the speakers to your local Wi-Fi network.

9. When the process is completed, tap “Continue”.

10. Go back to the KEF Connect App to start using the speakers.



- The Wi-Fi icon on the top panel of the Primary Speaker is solid white when the speakers are successfully connected.

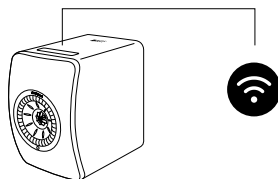

- After successful connection, you may be prompted if there is a new firmware update available. Follow the instructions in the KEF Connect App to complete the update process.

4.3.4 Using Android Devices without Google Play Service

1. Make sure your mobile device is connected to your local Wi-Fi network.
2. Launch and login to the KEF Connect App on your mobile device.
3. Allow the app to access your device's location when requested.
4. Tap “Choose a Wi-Fi network”.
5. Select your local Wi-Fi network and then tap “OK”.

[Step 3–5]

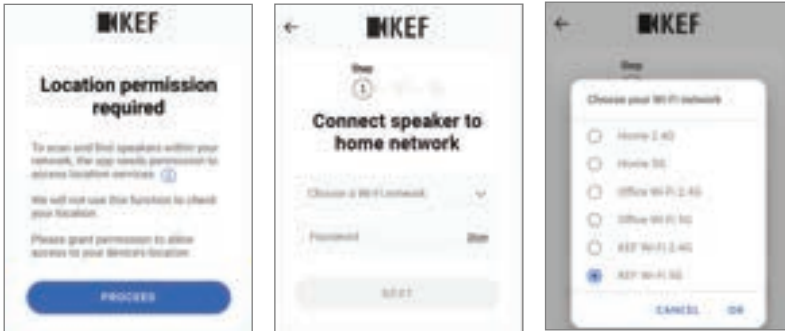

6. Input the password of your local Wi-Fi network and then tap “Next”. The connection process will be done automatically.
7. If preferred, create a new name for the speakers and then tap “Next”. This name will be used for Wi-Fi and Bluetooth connections.
8. Tap “Let’s start” to enjoy your speakers.

[Step 6–8]

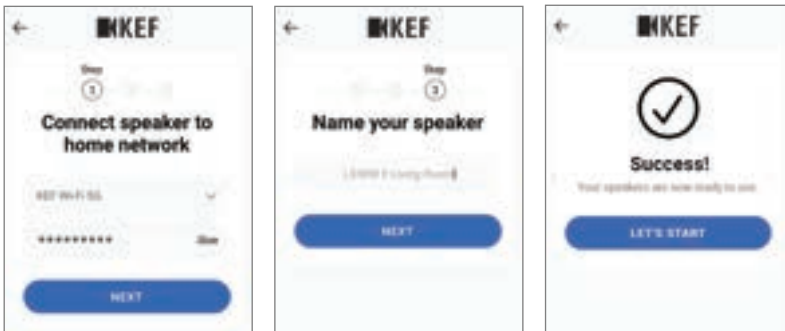



- The Wi-Fi icon on the top panel of the Primary Speaker is solid white when the speakers are successfully connected.

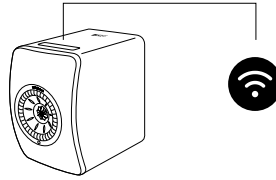

- After successful connection, you may be prompted if there is a new firmware update available. Follow the instructions in the KEF Connect App to complete the update process.

4.4 Speaker Placement and Connection

- The speakers should be placed on a flat and level surface that is free from vibration.
- The two speakers are distinguished between the Primary Speaker and the Secondary Speaker. By default, the Primary Speaker is the right channel* and should be placed on your right hand side as you face the speakers. For the best stereo experience, soundstage and stable connection, place the speakers within 8 meters apart.

*The left and right channels can be swapped through the KEF Connect App. See chapter "[Speaker System Options – Inverse L/R Speaker](#)".

- The optimum distance between the speakers and the listener will depend on how far the Primary Speaker and the Secondary Speaker are separated, or vice versa. Try to keep the same distance to the listener to form an equilateral triangle.

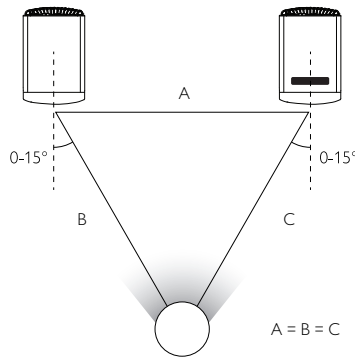

- The two speakers are already paired and will be automatically connected with each other wirelessly (resolution: 96 kHz/24 bit). If you prefer a higher resolution (192 kHz/24 bit) or are experiencing frequent audio dropouts due to interference, use the provided inter-speaker cable (length: 3 m) to link the two speakers (see chapter "[Back Panel](#)").
- If a longer inter-speaker cable is required, the [K-Stream cable](#) (6 m) is recommended.



Maximum Distance between the Two Speakers

| | |
|---------------|--|
| Wireless Mode | Up to 8 meters. Note that RF interference, including Wi-Fi and Bluetooth, may reduce this distance. |
| Wired Mode | Use the provided inter-speaker cable or connect with a shielded Cat-6 Ethernet cable. The maximum cable length is 10 meters. |

5. Connection and Control Interface

5.1 Front Panel

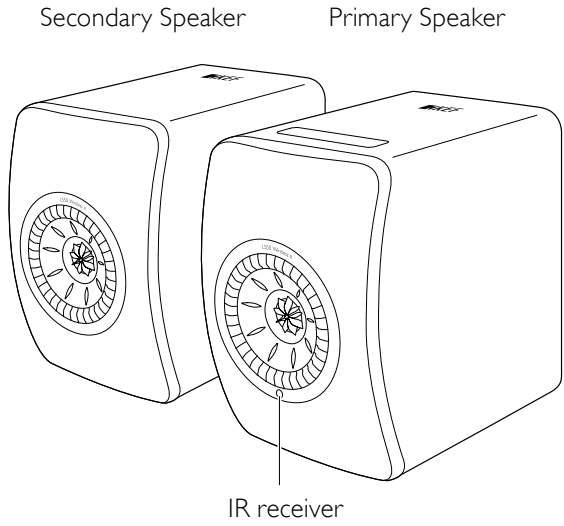

5.2 Back Panel

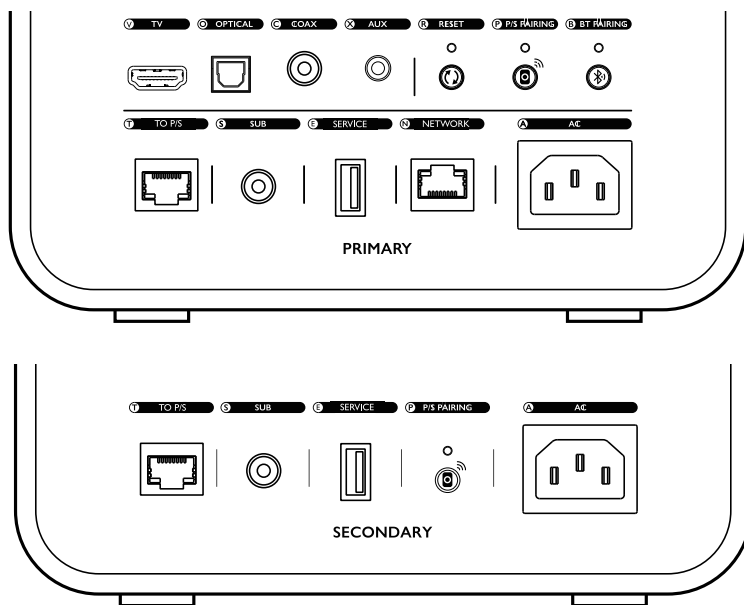

Controls and connections are found on the back panel of each speaker, marked as shown.

| | |
|-------------------------------|--|
| V TV port | Plays audio input from a source (e.g. ARC/eARC port of television) through an HDMI cable. |
| O Optical input jack | Plays audio input from a source (e.g. Blu-ray player, cable box) through an optical cable. |
| C Coaxial input jack | Plays audio input from a source (e.g. audio player) through a coaxial cable. |
| X Auxiliary input jack | Plays audio input from a source (e.g. turntable with phono stage) through a 3.5 mm audio cable. |
| R Factory reset button | Resets the speakers to the factory defaults (including network settings and all EQ and system preferences). Press and hold the button until the indicator light above the button blinks. |
| P P/S pairing button | Re-establishes the connection between the Primary Speaker and the Secondary Speaker if the connection is lost. |

| | | |
|----------|-----------------------------------|---|
| B | Bluetooth pairing button | Enables Bluetooth pairing. The speakers will be ready to pair with a new device. Any Bluetooth connected device will be disconnected. |
| T | Primary/Secondary connection port | Connects the Primary Speaker and Secondary Speaker with the inter-speaker cable. |
| S | Subwoofer output jack | Connects a subwoofer to the speakers through an RCA cable. |
| E | Service port | Connection port for service. |
| N | Network port | Connects the speakers to a router with a LAN cable. |
| A | AC input connector | Connects the speakers to the power source with the power cables. |

5.3 Bottom Panel

- Rubber feet are found on the bottom panel of each speaker to prevent slipping on a hard surface.

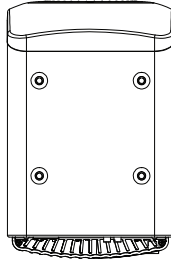

- Additionally, four threaded holes (M8 × 1.5) are also available for mounting on a stand (remove the rubber feet first before mounting). For the best sound performance and cable management, use the [KEF S2 speaker stands](#).

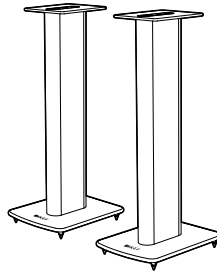

⚠ WARNING!

Be aware of the potential hazards from tipping or knocking the speakers off the stands which may result in personal injury, or property damage.

5.4 Top Panel

Control buttons and mode indicators are found on the top panel of the Primary Speaker.

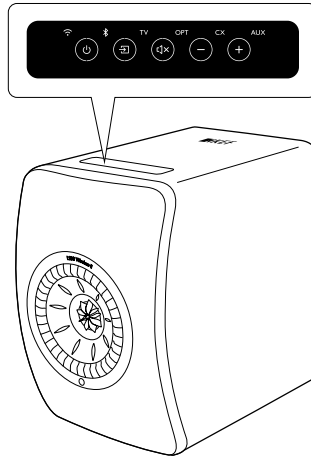

Mode indicator

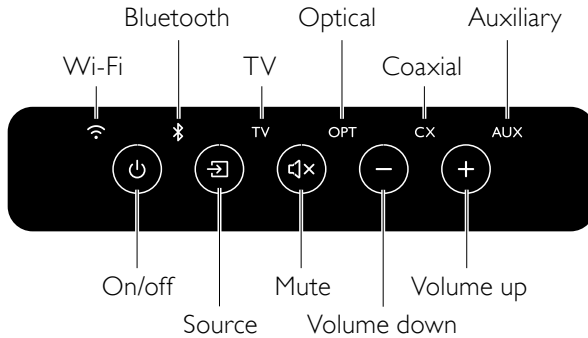

Control button

5.5 Remote Control

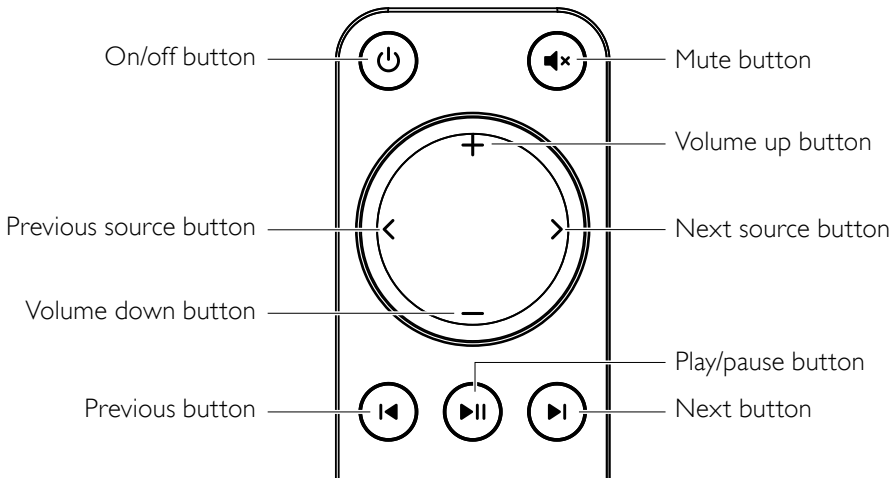

- Insert two AAA batteries into the battery compartment before use. To do so, slide open the battery compartment cover on the back and insert the batteries into the compartment according to the polarity (+/-). Close the battery compartment cover when done.
- Point the remote control to the IR receiver located on the front panel of the Primary Speaker. Make sure there are no obstacles between the remote control and the Primary Speaker during use.
- If the remote control is less responsive or not working, the battery power may be low. Replace the batteries.

5.6 KEF Connect App

The KEF Connect App allows you to set up the speakers, apply sound settings, turn on/off the speakers, switch sound sources, and access and play back your streaming music and music stored in media server.

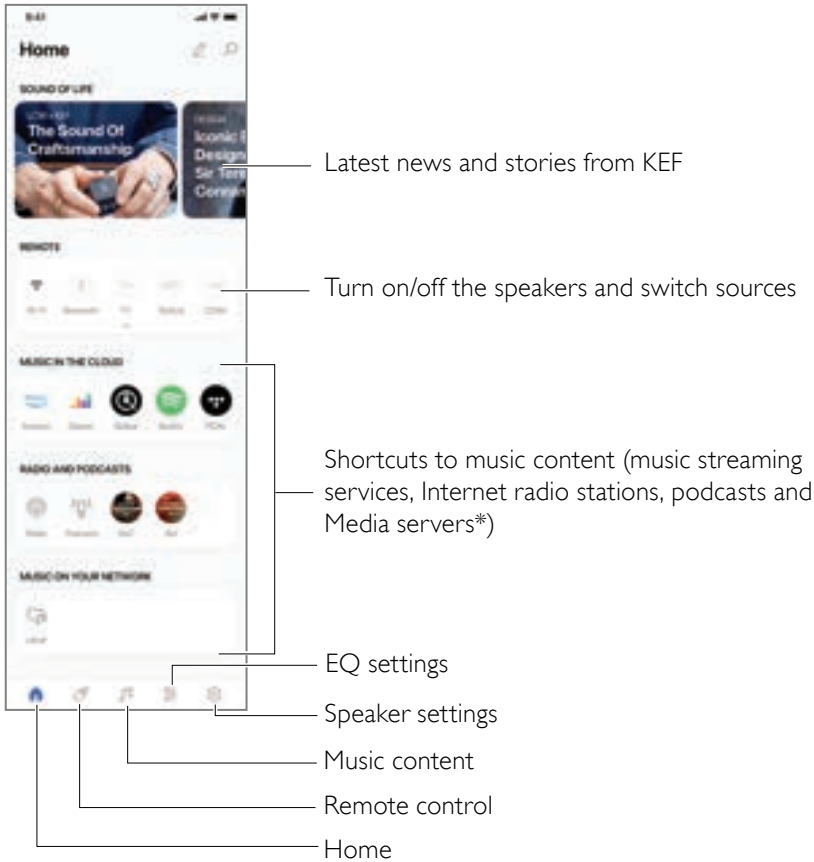

*Coming soon



For details, see chapter "[Using KEF Connect App](#)".

6. Wi-Fi Streaming

6.1 Wireless Streaming Protocols

-  To stream audio to the speakers, your mobile device must be connected to the same Wi-Fi network as the speakers. The speakers can be turned on from standby mode through all wireless streaming protocols.



6.1.1 AirPlay 2

AirPlay 2 lets you share audio output from Apple devices to the speakers.



1. Start music or video playback on your iOS device.
2. For music streaming, tap the AirPlay icon () in the playback screen.



For audio streaming from the YouTube app, tap the connection icon () in the playback screen and then tap the AirPlay icon ().

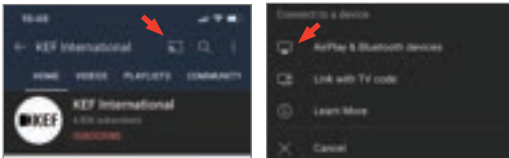

3. Select “KEF LS50 Wireless II” (or the name you have created for the speakers) from the selection menu to start streaming.

-  The availability for streaming depends on the app compatibility.

6.1.2 Chromecast

If your device is Chromecast-enabled, you can stream audio output from the device to the speakers.



1. Start music or video playback on your Chromecast-enabled device.
2. In the Google Home App, tap "KEF LS50 Wireless II" (or the name you have created for the speakers).
3. Tap "Cast my audio".



The availability for streaming depends on the app compatibility.

6.1.3 ROON Ready (coming soon)



Roon is a high quality music management system that pulls together music from a NAS drive, locally stored music (i.e. on your computer), compatible streaming services and Dropbox to create a searchable, surfable magazine about your music. The speakers are certified “Roon Ready”. For more information on Roon, visit roonlabs.com.

1. Enable the speakers in the Audio menu.



Note: KEF LS50 Wireless II will be Roon Ready soon.

2. To stream music, click the “Zone Picker” next to volume at the footer of Roon and then select “KEF LS50 Wireless II” (or the name you have created for the speakers) from the device list.

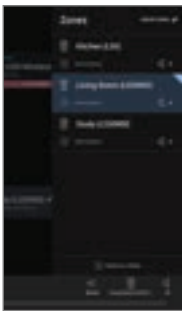

3. The signal path can be found by clicking the little coloured light in the footer:



6.1.4 Music Streaming Apps Native Protocols

6.1.4.1 Spotify Connect



Spotify is a digital music and podcast streaming service that gives you access to millions of songs and other content from artists all over the world. The speakers are ready for Spotify Connect.

1. Browse and select music to play in the Spotify App.
2. Tap the device icon () at the bottom of the playback screen.
3. Select “KEF LS50 Wireless II” (or the name you have created for the speakers) from the selection menu to start streaming.

[Step 1–3]

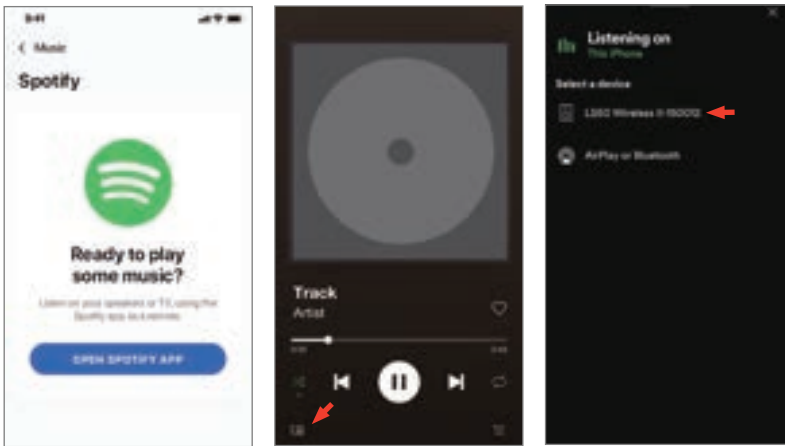

6.1.4.2 QPlay



QQ Music is one of China's most popular online music streaming services. QPlay lets you stream music directly from the QQ Music App. The speakers are ready for the QPlay feature.

1. To stream music, launch the QQ Music App and enable QPlay in the settings.
2. Browse and play music.
3. Tap the QPlay icon () on the playback screen.

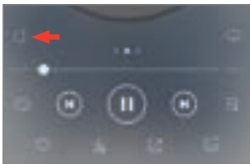

4. Select "KEF LS50 Wireless II" (or the name you have created for the speakers) from the device list to start streaming.



6.1.4.3 TIDAL Connect

T I D A L connect

TIDAL is a subscription-based music, podcast and video streaming service that combines lossless audio and high-definition music videos with exclusive content and special features on music. The speakers are ready for the TIDAL Connect feature for music streaming.

1. To stream music, select the content you want to play in the TIDAL Connect App and then select the connect icon () in the “Now Playing” screen.
2. Select “KEF LS50 Wireless II” (or the name you have created for the speakers) from the list of nearby devices to pair with the Tidal Connect App to start streaming.

[Step 1–2]

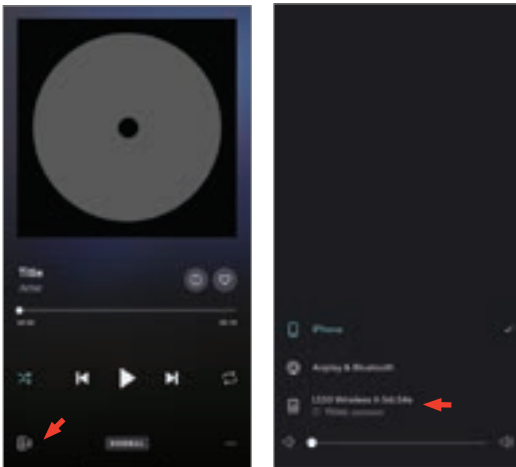

6.1.5 KEF Connect App Streaming



The KEF Connect App offers direct access to various music streaming services for playback through the speakers. For details, see chapter [“Playing Music from Music Streaming Services”](#)

6.1.5.1 Amazon Music



Amazon Music is a music streaming platform and online music store operated by Amazon. You can access your Amazon Music account through the KEF Connect App to stream music to the speakers.

6.1.5.2 Deezer



Deezer is an online music streaming service. It allows users to listen to music content from a wide range of record labels on various devices online or offline. You can access your Deezer account through the KEF Connect App to stream music to the speakers.

6.1.5.3 Qobuz



Qobuz is a music streaming and downloading service offering hi-resolution streaming to its subscribers. You can access your Qobuz account through the KEF Connect App to stream music to the speakers.

6.1.5.4 Spotify



Through the KEF Connect App, you will be prompted to open the Spotify app on your device in order to stream music to the speakers. See chapter [“Spotify Connect”](#).

6.1.5.5 TIDAL



TIDAL is a subscription-based music, podcast and video streaming service that combines lossless audio and high-definition music videos with exclusive content and special features on music. You can access your TIDAL account through the KEF Connect App to play hi-resolution audio. A valid Hi-Fi tier subscription is required.

6.1.5.6 Internet Radio

The KEF Connect App offers access to thousands of Internet radio stations from all over the world, offering music, news and discussion.

6.1.5.7 Podcast

The KEF Connect App provides access to a wide range of podcasts covering a huge number of genres and topics.

6.1.6 UPnP Playback

You can play compatible music files stored in the music library of a connected media server (e.g. NAS drive via uPnP). The media server must be on the same network as the speakers.

6.2 Tips on Choosing Streaming Protocols

Recommendations for the best wireless streaming options with regard to music/media apps on your mobile devices.

| App | Wireless streaming protocol | | | | | |
|-----------------|-----------------------------|------------|------------|-------------------------------------|-----------------|-----------|
| | AirPlay 2 | Chromecast | ROON Ready | Music streaming app native protocol | KEF Connect App | Bluetooth |
| Spotify | ✓ | ✓ | – | Spotify Connect ✓ | – | ✓ |
| TIDAL | ✓ | ✓ | ✓ | TIDAL Connect ✓ | ✓ | ✓ |
| QQ Music | ✓ | ✓ | – | QPlay ✓ | – | ✓ |
| Apple Music | ✓ | ✓ | – | – | – | ✓ |
| Amazon Music | ✓ | ✓ | – | – | ✓ | ✓ |
| Deezer | ✓ | ✓ | – | – | ✓ | ✓ |
| Qobuz | ✓ | ✓ | ✓ | – | ✓ | ✓ |
| Internet radio | ✓ | ✓ | – | – | ✓ | ✓ |
| Audio podcast | ✓ | ✓ | – | – | ✓ | ✓ |
| Youtube (audio) | ✓ | ✓ | – | – | – | ✓ |

✓ = Supported

✓ = Supported and recommended for the best audio quality and streaming stability.

7. Multi-Room Streaming

7.1 AirPlay 2

Apple Airplay 2 can extend the speakers to become part of a multi-room wireless music system which can be controlled with iOS devices. If you have more than one pair of AirPlay 2 speakers connected to the same network, select the pairs for playback of the same audio output at the same time.



You can control the volume of the speakers individually or together as a group.

Note: AirPlay speakers are not compatible with multi-room streaming.

7.2 Chromecast

You can group the speakers and Chromecast devices together for synchronous music throughout the home.

1. Make sure your mobile device is connected to the same Wi-Fi network or linked to the same account as your speakers.
2. Open the Google Home App.
3. At the top left, tap “+” and then “Create a speaker group”.

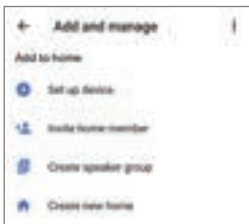

4. Tap each device (including the sets of speakers) you want to add to the group. A check mark will appear next to each device you have selected.



5. Tap “Next”
6. Enter a name for your group.



7. Tap “Save”.

7.3 ROON

With Roon Ready certification, the speakers are compatible with Roon's multi-room streaming functionality.

Roon supports "Zone Grouping", or synchronizing audio playback in several zones within your house. Note that "Zones" can only be grouped with other zones of the same type (e.g. RAAT, AirPlay etc.).

1. To group zones, select the zone you are controlling in desktop and tablet interface, by clicking the "Zone Picker" in the footer, next to volume.

On a phone, select by clicking "Switch Zone" below the volume pop-up.

2. Tap "Group Zones". This brings up the available zones for grouping.



3. Select the desired zone(s) to be added and then tap "Save".



The speakers in the grouped zones will stream the same audio output.

8. Voice Control Over Mobile Device

8.1 Siri

You can use Siri to control playback (e.g. skipping tracks, controlling the volume level) while your iOS mobile device is streaming music to the speakers.

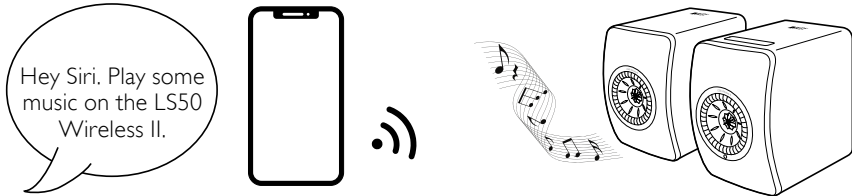

8.2 Google Assistant

You can use Google Assistant to control playback (e.g. skipping tracks, controlling the volume level) while your Android mobile device is streaming music to the speakers.

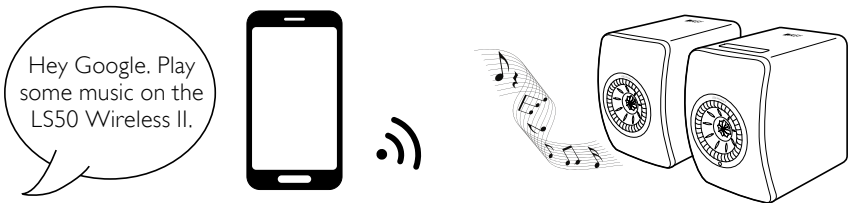

9. Playback with Bluetooth

You can pair your Bluetooth devices (e.g. computers) with the speakers through Bluetooth connection. The speakers must always be first connected to your local network before Bluetooth connection.

9.1 Selecting Bluetooth Mode

- In the KEF Connect App, tap the Bluetooth button (📶) to switch to Bluetooth mode.



- Alternatively, press the source button on the top panel of the Primary Speaker;
- Or, press the source button on the remote control.



You can assign the Bluetooth mode as a second wake-up source to turn on the speakers automatically when there is audio input through Bluetooth connection. See chapter "[Power Saver – Second Wake-Up Source](#)".

9.2 Bluetooth Pairing

1. In Bluetooth mode, check the Bluetooth icon on the top panel of the Primary Speaker. When the Bluetooth icon pulses slowly, the speakers are in the discovery mode and ready to pair with a Bluetooth device.



If the Bluetooth icon is constantly lit, the speakers are already paired with a Bluetooth device. To disconnect the connected Bluetooth device, short press the Bluetooth pairing button (B) on the back panel of the Primary Speaker. The Bluetooth icon blinks slowly when it is ready to pair with a new Bluetooth device.

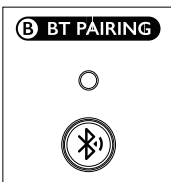

Alternatively, press the Bluetooth pairing icon located at the upper right corner of the remote control in the KEF Connect App to disconnect the paired device.



2. Turn on the Bluetooth feature of your device and select “KEF LS50 Wireless II” (or the name you have created for the speakers) from the list of available devices to pair.

When Bluetooth pairing is done, the Bluetooth icon will stay lit.

- i** The speakers remember your last paired Bluetooth device. Once Bluetooth mode is selected, the speakers will automatically connect with your last paired device if it is around.

9.3 Playback Controls

In the KEF Connect App, use the control elements below for playback controls.



- i** The volume can also be adjusted on the top panel or remote control.
- The previous and next functions can also be operated on the remote control.

10. Playback with HDMI eARC input

The speakers are compatible with HDMI eARC (enhanced Audio Return Channel) output from your TV for integrated control through a single HDMI cable. The speakers must always be first connected to your local network before HDMI connection.

The speakers are also backward compatible with ARC and HDMI CEC. HDMI CEC allows the use of the television remote control to adjust the volume of the speakers.

10.1 HDMI Cable Connection

Connect the HDMI output port of your TV and the TV port (V) on the back panel of the Primary Speaker via an HDMI cable.

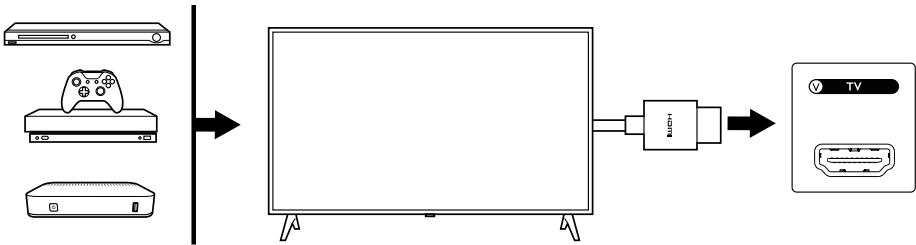

- Connect the HDMI cable to the eARC or ARC port of your TV.
- In your TV setting, turn on eARC, ARC or CEC in the HDMI settings.
- Refer to the user manual of your TV for details as manufacturers may name the HDMI connections differently (e.g. Anynet+ for Samsung, Simlink for LG). Make sure the digital audio output setting for the television is set to PCM (not Dolby, Bitstream, Auto or similar).

10.2 Selecting TV Mode

- In the KEF Connect App, tap the TV Mode button (TV) to switch to TV Mode.



- Alternatively, press the source button on the top panel of the Primary Speaker;
- Or, press the source button on the remote control.
- If no HDMI cable is connected to the speakers and TV mode is selected, the TV icon will keep pulsing.



- The TV icon is lit when HDMI connection is established.



You can assign TV mode as a second wake-up source to turn on the speakers automatically when there is audio input through the HDMI connection. See chapter "[Power Saver – Second Wake-Up Source](#)".

10.3 Playback Controls

All playback controls (except adjusting volume) must be done on the connected device.



The volume can also be adjusted on the top panel or remote control.

11. Playback with Optical Input

You can connect your devices with optical output (e.g. TV and game consoles) to the speakers through an optical cable. The speakers must always be first connected to your local network before optical connection.

11.1 Optical Cable Connection

Connect the optical output jack of your device and the optical input jack (O) on the back panel of the Primary Speaker via an optical cable.

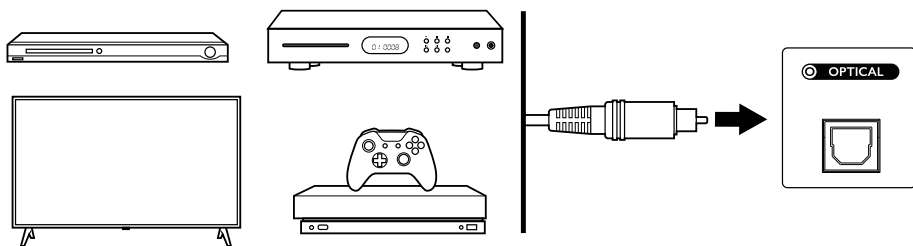

Make sure your TV is set to output digital audio in PCM format. Refer to the user manual of your TV for details.

11.2 Selecting Optical Mode

- In the KEF Connect App, tap the Optical Mode button (OPT) to switch to Optical Mode.



- Alternatively, press the source button on the top panel of the Primary Speaker;
- Or, press the source button on the remote control.
- The OPT icon is lit when Optical mode is selected.



-  You can assign Optical mode as a second wake-up source to turn on the speakers automatically when there is audio input through the optical connection. See chapter "[Power Saver – Second Wake-Up Source](#)".

11.3 Playback Controls

All playback controls (except adjusting volume) must be done on the connected device.

-  The volume can also be adjusted on the top panel or remote control.

12. Playback with Coaxial Input

You can connect your devices with coaxial output (e.g. DVD/CD player) to the speakers through a coaxial cable. The speakers must always be first connected to your local network before coaxial connection.

12.1 Coaxial Cable Connection

Connect the coaxial output jack of your device and the coaxial input jack (C) on the back panel of the Primary Speaker via a coaxial cable.

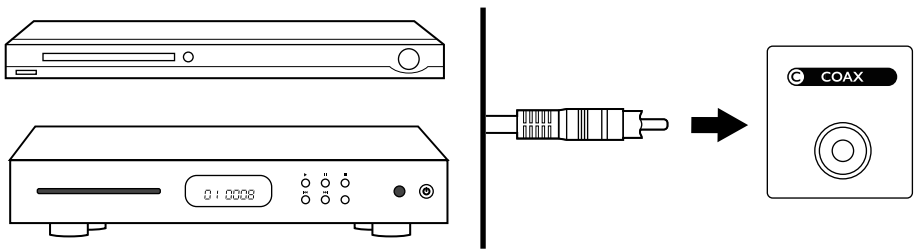

12.2 Selecting Coaxial Mode

- In the KEF Connect App, tap the Coaxial button (CX) to switch to Coaxial mode.



- Alternatively, press the source button on the top panel of the Primary Speaker;
- Or, press the source button on the remote control.
- The CX icon is lit when Coaxial mode is selected.



-  You can assign Coaxial mode as a second wake-up source to turn on the speakers automatically when there is audio input through the coaxial connection. See chapter "[Power Saver – Second Wake-Up Source](#)."

12.3 Playback Controls

All playback controls (except adjusting volume) must be done on the connected device.

-  The volume can also be adjusted on the top panel or remote control.

13. Playback with Auxiliary Input

You can connect your devices with 3.5 mm audio output (e.g. turntables, computers, portable music players) to the speakers through an audio cable. The speakers must always be first connected to your local network before auxiliary connection.

13.1 Auxiliary Cable Connection

Connect the audio output jack of your device and the auxiliary input jack (X) on the back of the Primary Speaker via a 3.5 mm audio cable.

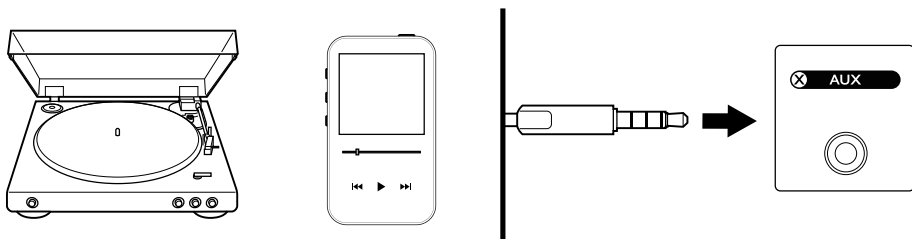

13.2 Selecting Auxiliary Mode

- In the KEF Connect App, tap the Auxiliary Mode button (AUX) to switch to Auxiliary mode.



- Alternatively, press the source button on the top panel of the Primary Speaker;
- Or, press the source button on the remote control.
- The AUX icon is lit when Auxiliary mode is selected.



- i** You can assign Auxiliary mode as a second wake-up source to turn on the speakers automatically when there is audio input through the auxiliary connection. See chapter "[Power Saver – Second Wake-Up Source](#)".

13.3 Playback Controls

All playback controls (except adjusting volume) must be done on the connected device.

- i** The volume can also be adjusted on the top panel or remote control.

14. Using KEF Connect App

The KEF Connect App allows you to set up the speakers, apply EQ settings, turn on/off the speakers, switch sound sources and access and play back your music streaming services.

14.1 Home

14.1.1 Overview

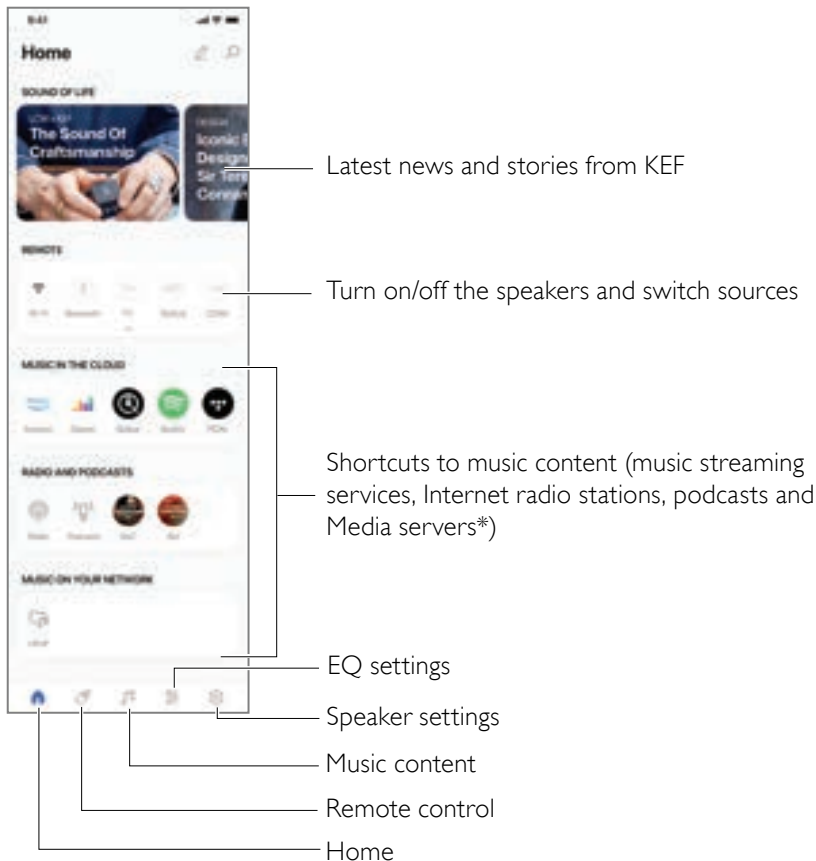

*Coming soon

14.1.2 Editing the Home Screen (coming soon)

You may edit the Home screen to show or hide tiles (e.g. Music in the Cloud) or buttons that are of frequent or less frequent use.

1. Tap the edit icon () at the top right of the app.
2. Tap the “+” or “-” symbols to show or hide a tile.



3. Tap the edit icon () at the top right of a tile.
4. Tap the “+” or “-” symbols to show or hide a button in the tile.



14.2 Remote Control

- Use the buttons under “Remote Control” to directly turn on the speakers from that particular source, or change the sound source.



- To turn off the speakers, tap the active source button.

14.3 Music Content

The KEF Connect App allows you to access and play back music from your music streaming services as well as Internet radio stations and podcasts.

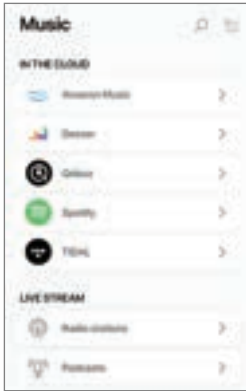

14.3.1 Playing Music from Music Streaming Services

14.3.1.1 Amazon Music



1. To stream music, tap “Amazon Music” under “Music in the Cloud” in the KEF Connect App.



2. Login to your Amazon Music account.



3. Browse and play music to start streaming.

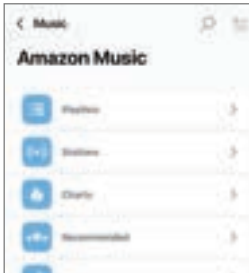

14.3.1.2 Deezer



1. To stream music, tap “Deezer” under “Music in the Cloud” in the KEF Connect App.



2. Login to your Deezer account.



3. Browse and play music to start streaming.



14.3.1.3 Qobuz



1. To stream music, tap “Qobuz” under “Music in the Cloud” in the KEF Connect App.



2. Login to your Qobuz account.

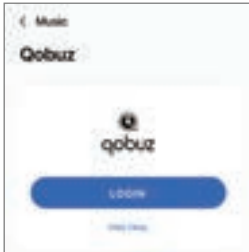

3. Browse and play music to start streaming.



14.3.1.4 Spotify



Through the KEF Connect App, you can be prompted to the Spotify App on your device to stream music to the speakers. See chapter "[Spotify Connect](#)".



14.3.1.5 TIDAL



1. To stream music, tap "TIDAL" under "Music in the Cloud" in the KEF Connect App.



2. Login to your TIDAL account.



3. Browse and play music to start streaming.



14.3.1.6 Internet Radio

1. To access Internet radio, tap “Radio stations” under “Live Stream” in the KEF Connect App.



2. Browse and play a radio station to start streaming.



14.3.1.7 Podcast

1. To access podcast contents, tap “Podcasts” under “Live Stream” in the KEF Connect App.



2. Browse and play a podcast to start streaming.



14.3.2 Playback Controls

The below features are available to control playback or behaviour. Please note that these features may not be available to all music sources and there may be slight differences in the control interface.

14.3.2.1 Playback Screen

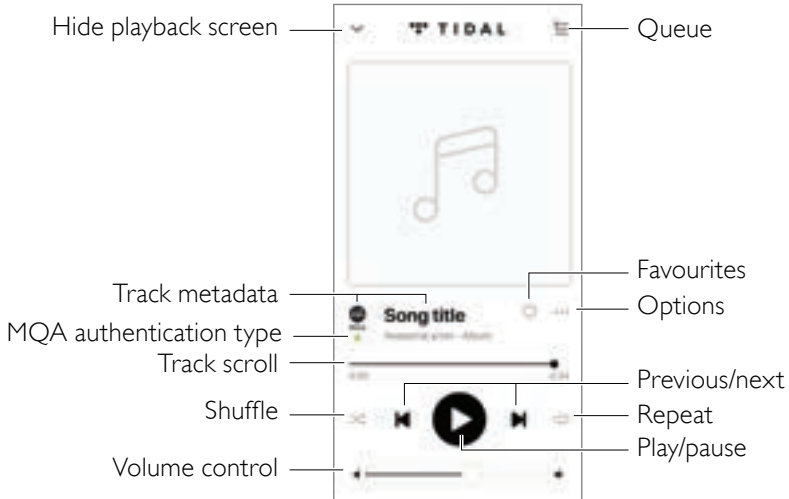

14.3.2.2 Search

Tap the search icon (🔍) to look for artists, albums or songs in the current music source.

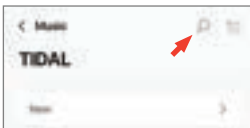

14.3.2.3 Favourites

- **Selecting or Deselecting Favourites**

In the playback screen, tap the favourite icon (♥) to select or deselect an item (music, podcast, radio station) as favourites.

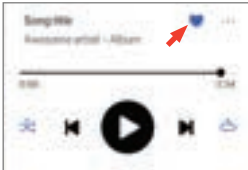

Alternatively, tap the option icon (⋮) next to an item (e.g. track, album, playlist), or press and hold on an item and then select “Add to Favorites” or “Remove from Favorites”.



- **Accessing your favourites**

To show the favourites in your current music source, tap “Favourites” in the main menu.



14.3.2.4 Play Queue

Adding a track to the queue means the track will be played after the current playing track. The queue is not permanent and cannot be saved.

- **Adding a Track to the Queue**

1. From the playback screen, tap the option icon (⋮).



2. Select "Add to Queue".



Depending on your selections, you can also add all tracks from an artist, all tracks from an album, or all tracks from a playlist to the queue.

- **Showing the Current Queue**

From the playback screen, tap the queue icon (≡) at the top right.



- **Editing the Queue**

1. To edit the playback sequence, press and hold the three bars (≡) on the right hand side of a track and then drag the track up or down the queue.

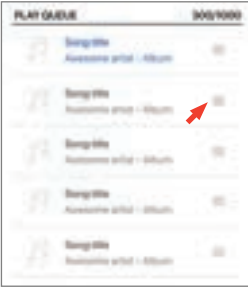

2. To remove a track from the queue, tap the edit icon (✎) at the top right.



3. Select the track in the queue and then tap the trash bin icon (🗑) to remove it from the queue. You may also select multiple tracks for removal.

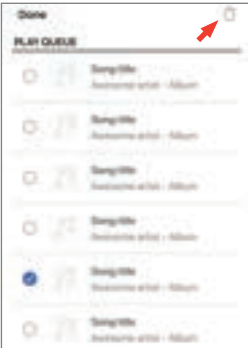

14.3.2.5 Playlists

A playlist is a list of tracks that can be played back in the preferred sequential order. Playlists can be saved for future listening.

- **Accessing the Playlists**

In the current music source, tap “Playlists” in the main menu.



- **Creating a Playlist**

1. In the current music source, tap “Playlists” in the main menu.
2. Tap “Create new playlist”.



3. Create a name for the playlist and then tap “Create”.



- **Adding Tracks to a Playlist**

1. From a list of tracks or from the playback screen, tap the option icon (⋮) on the right

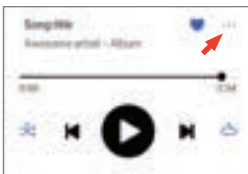

2. Tap “Add to playlist”.

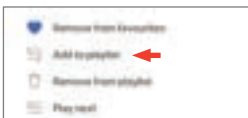

3. Select the playlist you want to add the track to.



Depending on your selections, you can also add all tracks from an artist or all tracks from an album to the playlist.

- **Editing a Playlist**

1. In the playback screen of the track to be removed, tap the option icon (⋮).



2. Tap "Remove from playlist".



- **Deleting a Playlist**

1. In the playlist, tap the option icon (⋮) at the top right corner.

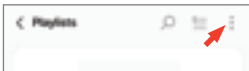

2. Tap "Delete playlist".



14.4 Equalisations

For the best audio performance, apply sound settings according to your listening area.

14.4.1 Normal Mode

1. In the KEF Connect App, tap the EQ settings icon () at the bottom of the Home screen.
2. Tap “Add new profile”

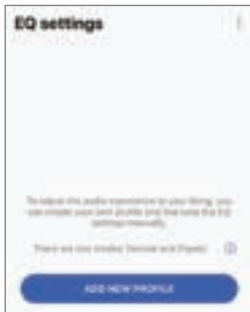

3. Select “Normal mode”.



4. Create a name for your new profile and then tap “Save”.



5. Configure the settings according to your listening area.



- Installation location: On a stand or on a desk
- Distance from the front edge of the table (on a desk only) (> 50 cm to 0 cm)

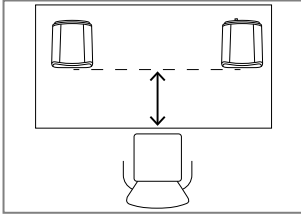

- Distance to the wall (< 10 cm to > 50 cm)

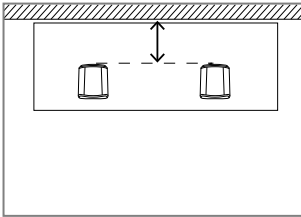

- How is your room? (Damped / Moderate / Lively)

Damped: Large furniture, thick carpet and heavy curtains

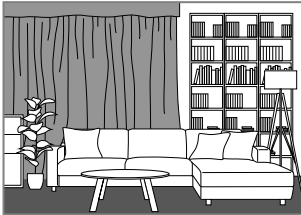

Moderate: Medium furniture, thinner carpet or rug, some curtains and features on walls



Lively: Hard floor; less furniture, large windows and no curtains



- How large is the room? (< 20 m² / 20–40 m² / > 40 m²)
- Subwoofer is plugged in (On/Off).

If a subwoofer is plugged in, set up the subwoofer volume and speaker/subwoofer balance.

6. Tap “Save” when the settings are done.

14.4.2 Expert Mode

1. In the KEF Connect App, tap the EQ settings icon () at the bottom of the Home screen.
2. Tap “Add new profile”.

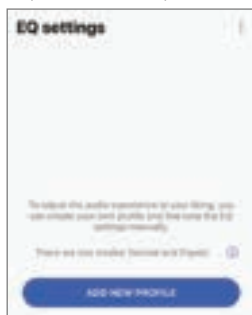

3. Select “Expert mode”.

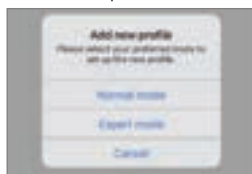

4. Create a name for your new profile and then tap “Save”.

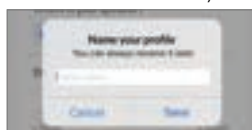

5. The Expert Mode lets you configure the EQ preferences in greater precision.



The settings include:

- Desk Mode (On/Off, -10.0 dB to 0.0 dB)
- Wall Mode (On/Off, -10.0 dB to 0.0 dB)
- Treble Trim (-4.0 dB to 4.0 dB)
- Phase Correction (On/Off)
- Bass Extension (Less / Standard / Extra)
- High-Pass Frequency (On/Off, 50 Hz to 120 Hz)
- Sub Out Low-Pass Frequency (40 Hz to 250 Hz)
- Sub Gain (-10 dB to 10 dB)
- Sub Polarity (On/Off)



Understanding the EQ Settings

On a desk/distance from the front edge of the table (Expert Mode: Desk Mode): This setting adjusts the “presence” region (170 Hz +/- 1 octave). Too much causes a muddy sound, while a lack of presence makes the sound distant and empty.

Distance to the wall (Expert Mode: Wall Mode): This setting adjusts all frequencies from around 500 Hz downwards, causing broader changes than Desk Mode. A dip in these frequencies causes a tinny sound, while too much of these frequencies can overwhelm the overall presentation with lower frequencies.

How is your room? (Expert Mode: Treble Trim): This adjusts the frequencies above 500 Hz. A damped room (lots of curtains, soft furnishings) can make sound seem muted, while a lively room (high ceiling, flat surfaces, glass) can make it sound harsh. Move towards damped to reduce the muting effect, or move towards lively to tame harshness.

How large is your room (Expert Mode: Bass Extension): This setting adjusts the bass extension of the speakers. The larger the room selected, the lower the roll-off point.



Understanding the Subwoofer Settings

Subwoofer/Speaker Balance (Normal mode): This controls the bass output between the subwoofer and the speakers. If the slider is moved more to “Subwoofer”, most of the bass output will be handled by the subwoofer.

High-Pass Frequency: Frequencies above the set point will be played by the speakers.

Sub Out Low-Pass Frequency: Frequencies below the set point will be handled by the subwoofer. This can overlap with the high-pass frequency to help integrate the speaker/subwoofer more effectively with no dip or peak in overall response.

Sub Gain: This changes the signal level output to the subwoofer.

Sub Polarity: Ideally, the speakers and subwoofer should be moving in the same direction at the same time, otherwise frequencies can be cancelled out. Switching the polarity of the subwoofer can resolve a perceived lack of bass response.

14.4.3 Selecting a Sound Profile

1. In the KEF Connect App, tap the EQ settings icon () at the bottom of the Home screen.
2. Tap “Default” and then select a sound profile to apply to the speakers. The profiles with a star icon are created in Expert mode.

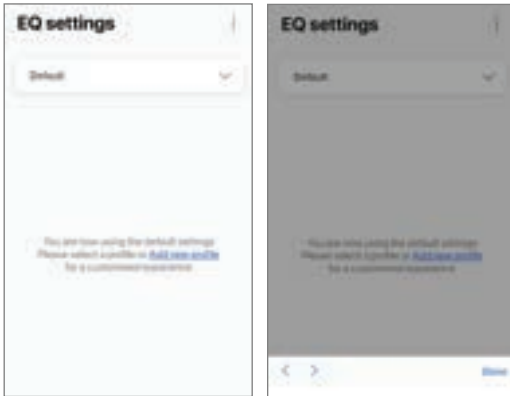

14.4.4 Renaming a Sound Profile

1. In the selected EQ profile, tap the option icon () at the top right.

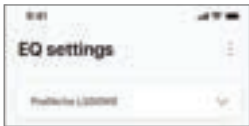

2. Tap “Rename profile”.

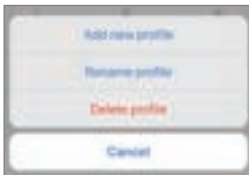

3. Create a new name for your profile and then tap “Save”.



14.4.5 Deleting a Sound Profile

1. In the selected EQ profile, tap the option icon (⋮) at the top right.



2. Tap “Delete profile”.



14.5 Profile

This menu allows you to edit your personal details (account name and profile picture) of your registered user account.

1. In the KEF Connect App, tap the Setting icon (⚙️) at the bottom of the Home screen.
2. Tap “View profile”.



3. Tap the edit icon (✎) at the top right and start editing.

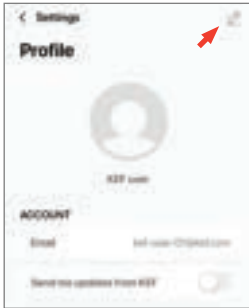

14.6 Choosing Your Speaker

14.6.1 My Speaker and Speakers Nearby

This menu allows the KEF Connect App to switch to another pair of speakers for control and streaming. All speakers must first be set up through the same KEF Connect App before they are available for selection.

1. In the KEF Connect App, tap the Setting icon (⚙️) at the bottom of the Home screen.
2. Tap the name of the connected speakers.



3. Select another pair of speakers for control and streaming.

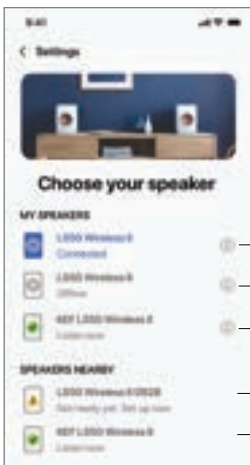

- Current speakers
- Speakers on the same network but turned off
- Speakers on the same network and ready for switching
- Not set up yet with KEF Connect App
- Already set up with KEF Connect App on another mobile device



The speakers under “Speakers Nearby” are on the same network but not ready yet to be controlled through the KEF Connect App on your mobile device.

14.6.2 Speaker Info

This menu allows you to find out more information about the connected speakers, rename the speakers and disconnect the speakers from the KEF Connect App.

1. In the KEF Connect App, tap the Setting icon (⚙️) at the bottom of the Home screen.
2. Tap the name of the connected speakers.



3. Tap the info icon (ⓘ) next to the name of the speakers.



4. Check the MAC address, IP address and firmware version of the speakers. You can also rename the speakers or forget the speakers (disconnect them from the KEF Connect App).

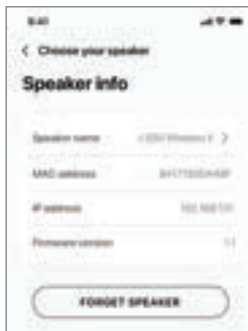

14.7 Speaker Preferences

This menu allows you to configure various speaker preferences. To access this menu:

1. In the KEF Connect App, tap the Setting icon (⚙️) at the bottom of the Home screen.
2. Tap “Speaker preferences”.



14.7.1 Power Saver – Standby Mode

This setting determines how long (ECO (20), 30 or 60 mins) the speakers will remain idle before automatically entering Standby Mode. If “never” is selected, the speakers must be manually turned off.



14.7.2 Power Saver – Second Wake-Up Source

This setting enables a second source to automatically turn on the speakers when there is audio input from the selected source. This option is not available when Standby Mode is set to ECO.



14.7.3 Do Not Disturb – Start Up Tone (coming soon)

This setting enables the start up tone to be muted when the speakers are turned on.



14.7.4 Do Not Disturb – Top Panel Lock

This setting enables the buttons on the top panel of the Primary Speaker to be disabled (child lock). The LED indicators will still be on. The control of the speakers can still be performed in the KEF Connect App and on the remote control.



14.7.5 Speaker System Options – Cable Mode

You can connect the Primary Speaker and Secondary Speaker with the provided inter-speaker cable through the “To L/R” connection ports on the back panels of the speakers. Once the cable is connected, enable this setting to enable Cable mode and disable the wireless connection.



Cable Mode is required/recommended when:

- You prefer a higher resolution at 192 kHz/24 bit (wireless: 96 kHz/24 bit).
- You are experiencing audio dropouts due to interference.

14.7.6 Speaker System Options – Inverse L/R Speakers

This setting changes which speaker plays left and right. By default, the Primary Speaker plays the right channel.

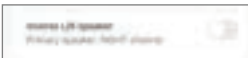

14.8 Volume

This menu allows you to configure volume settings. To access this menu:

1. In the KEF Connect App, tap the Setting icon (⚙️) at the bottom of the Home screen.
2. Tap “Volume”.



14.8.1 Volume Display Setting

This setting allows you to configure how the volume control should be displayed.



- None: No volume control will be displayed during playback.
- Slider: The volume control will be displayed as a slider for adjustment.



Tap the speaker icon on the left to mute or restore audio output from the speakers.

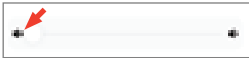

- -/+ : The volume control will be displayed as “-” and “+” buttons for adjustment.



Tap the speaker icon in the middle to mute or restore audio output from the speakers.



14.8.2 Hardware Volume

This setting is only available on iOS devices. The hardware volume buttons refer to the physical volume buttons on your device. Disable this setting when you are experiencing conflicts with other music streaming apps over Wi-Fi.



14.8.3 Speaker Volume Sensitivity

This setting allows you to configure the number of volume steps for each single press of the physical volume buttons of your device.



14.8.4 Maximum Volume

This setting allows you to configure the maximum level when adjusting the volume. The setting applies to all sources.



14.8.5 Balance Control

This setting allows you to adjust the volume balance between the left and right channels.



14.9 Firmware Upgrade

14.9.1 Automatic Firmware Update after Onboarding

After you have successfully set up the speakers with the KEF Connect App, you may be required to update the firmware if a new version is available. Follow the instructions in the KEF Connect App to complete the update process.



14.9.2 Automatic Firmware Check

The speakers check the server every 4 hours if a new firmware update is available. If a firmware is available, it will check if the firmware update is compulsory or not.

If a firmware update is compulsory, it will start the update when:

- The speakers are in standby mode, or
- The Wi-Fi source or Bluetooth source has been idle for 60 minutes.

If a firmware update is not compulsory, it will be carried out when:

- The speakers are in standby mode between 2–3 am, or
- The Wi-Fi source or Bluetooth source has been idle for 60 minutes.

A firmware update will not occur when the speakers are in use.

14.9.3 Manual Firmware Update

This menu allows you to manually check for firmware updates.

To access this menu:

1. In the KEF Connect App, tap the Setting icon (⚙️) at the bottom of the Home screen.
2. Tap “Speaker update”.



3. If an update is available, tap “Update now” to proceed with the firmware update.

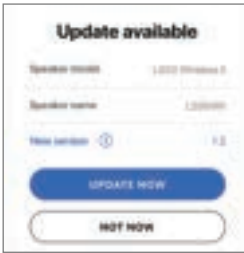

14.10 Application

This menu allows you to customise the streaming audio quality, theme and send analytics.

To access this menu:

1. In the KEF Connect App, tap the Setting icon (⚙️) at the bottom of the Home screen.
2. Tap “Application”.



14.10.1 Streaming Settings – Audio Quality

This setting allows you to select the audio quality for music streaming.



- Hi-Fi (Hi-Fi quality): Always select this setting for the best audio quality. The highest quality depends on the music streaming service and your subscription.
- High (CD quality): Select this setting when the speakers are in a crowded network and experiencing quality drop-outs.
- Normal (MP3 quality): Select this setting when the speakers are in a crowded network and experiencing audio drop-outs.

14.10.2 Theme Settings – Dark Theme (coming soon)

This setting allows you to change the app to a dark background. This improves text readability in a low light environment and saves battery life.



14.10.3 Theme Settings – Reset Home Screen (coming soon)

This setting allows you to reset the Home screen of the app to default settings.



14.10.4 Analytics – Improve App/Speaker

This setting allows the KEF Connect app to anonymously send improvement analytics to KEF. We recommend this setting is enabled to help KEF to improve product performance

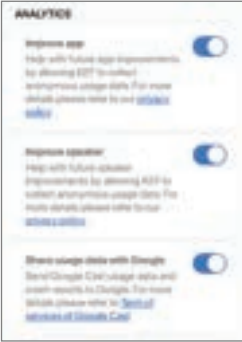

14.11 Support

This menu allows you to report issues, give suggestions and make general enquiries.

To access this menu:

1. In the KEF Connect App, tap the Setting icon (⚙️) at the bottom of the Home screen.
2. Tap "Support".



3. Select the type of support you need and proceed as instructed on the screen.

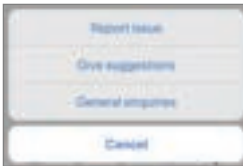

4. When reporting an issue, your email program will automatically attach the speaker logs that helps KEF investigate the issue. Please add a description of the problem in the email message as well.



15. Cleaning and Maintenance

⚠ WARNING!

Risk of electric shock!

Improper cleaning of the speakers may result in injury.

- Always unplug the power cables from the power sockets/outlets before cleaning the speakers.

NOTICE!

Risk of short circuit!

Water and other liquids that have penetrated the housing may cause a short circuit.

- Make sure that no water or other liquids penetrate the housing of the speakers.
- Never immerse the speakers in water or other liquids.

NOTICE!

Risk of damage!

Improper handling of the speakers may result in damage.

- Do not use any aggressive cleaners, brushes with metal or nylon bristles, or sharp or metallic utensils such as knives, hard scrapers and the like. They could damage the surface.

1. Disconnect the power cables of the speakers from the power sockets/outlets before cleaning.
2. Clean the surfaces of the speakers with a clean lint-free cloth. If necessary, use an alcohol-free cleaner (e.g. screen cleaner; eyeglass lens cleaner) to remove stubborn stains.
3. To clean the Uni-Q drivers (speaker cones), use an anti-static cleaner and a soft sponge. Be careful as the driver may be damaged if too much force is used.

16. Disposal

16.1 Disposing of the Packaging

Sort the packaging before you dispose of it. Dispose of paperboard, cardboard and wrappings in accordance with your local guidelines.

16.2 Disposing of the Speakers

Old appliances may not be disposed of in the household waste!

LS50 Wireless II is an electronic product and may not be able to be disposed of as household waste. Please dispose of your speaker in accordance with the regulations in force in your city or county. This ensures that old appliances are recycled in a professional manner and reduces negative consequences.

16.3 Disposing of the Battery

Batteries may not be disposed of with household waste!

As the end user you are required by law to bring all batteries, regardless whether they contain harmful substances* or not, to a collection point run by the communal authority or to a retailer, so that they can be disposed of in an environmentally friendly manner.

* labeled with: Cd = cadmium, Hg = mercury, Pb = lead

17. FAQ and Troubleshooting

17.1 Set-up

1. How do I set up LS50 Wireless II?

- First of all, a home Wi-Fi network is required. This is to ensure you can enjoy the full range of features and keep the system up to date.
- Then, download the KEF Connect App from the App Store or Google Play Store and install it on your mobile device. Follow the instructions in the KEF Connect App to get the speakers connected (onboarded) to your home Wi-Fi network.

2. What router specifications does LS50 Wireless II support?

- IEEE 802.11a/b/g/n/ac, IPv4, IPv6, Dual-band 2.4 GHz / 5 GHz
- For better streaming stability, especially on hi-resolution music files, a 5 GHz Wi-Fi network with a router transmission speed of at least 1300 Mbps is recommended.
- Office, hotel, guest and public networks often feature additional security or authentication methods which may prevent the speakers from connecting. You may need the help of the network administrator to configure the network to allow full functionality if using these kinds of networks.
- LTE routers/mobile hotspots will work, but may also consume a significant amount of battery power and mobile data.

3. Can I use a mesh router?

- Yes, we have tested the most popular mesh routers and they are working well with LS50 Wireless II. However, as there is not yet an industrial standard for mesh routers, each manufacturer may have their own meshing technology. If your mesh router does not work with LS50 Wireless II, make sure you have updated your router to the latest firmware or contact the manufacturer for solutions.

4. How far apart can I place the two speakers?

- Wireless: up to 8 meters apart depending on your network condition. A congested network environment will have more interferences and may reduce this distance.
- Wired: Cable length up to 10 meters.
- Optimal listening distance between the speakers and the listener will depend on how far the Primary Speaker and Secondary Speaker are separated from each other. Try to aim for approximately the same distance between the Primary Speaker and Secondary Speaker and between the speakers and the listener.

5. How large a room can LS50 Wireless II cover?

- 10–100 m²

6. Can I change the Primary Speaker as the left channel?

- By default, the Primary Speaker is the right channel and the Secondary speaker is the left channel. After connecting the speakers to your home Wi-Fi network, you can [invert the L/R channels](#) in the KEF Connect App.

7. Do I need to pair the two speakers?

- No, the two speakers are already paired at the factory. If you do not hear any sound from the Secondary Speaker, see chapter "[Troubleshooting](#)".

8. What is the purpose of the ethernet cable in the packaging box?

- Use this inter-speaker cable to connect the Primary Speaker and Secondary Speaker if you prefer a higher sound resolution (192 kHz/24 bit), or if the wireless connection between the speakers is not stable. After connecting the inter-speaker cable, you must also enable [Cable Mode](#) in the KEF Connect App.

9. Can I rename the speaker?

- Yes, [renaming](#) can be done in the KEF Connect App. This will change the name for both Wi-Fi and Bluetooth connections.

17.2 Playback and Streaming

1. Which is the best wireless streaming option for different apps?

- Recommendations for the best wireless streaming options with regard to music/media apps on your mobile devices.

| App | Wireless streaming protocol | | | | | |
|-----------------|-----------------------------|------------|------------|-------------------------------------|-----------------|-----------|
| | AirPlay 2 | Chromecast | ROON Ready | Music streaming app native protocol | KEF Connect App | Bluetooth |
| Spotify | ✓ | ✓ | – | Spotify Connect ✓ | – | ✓ |
| TIDAL | ✓ | ✓ | ✓ | TIDAL Connect ✓ | ✓ | ✓ |
| QQ Music | ✓ | ✓ | – | QPlay ✓ | – | ✓ |
| Apple Music | ✓ | ✓ | – | – | – | ✓ |
| Amazon Music | ✓ | ✓ | – | – | ✓ | ✓ |
| Deezer | ✓ | ✓ | – | – | ✓ | ✓ |
| Qobuz | ✓ | ✓ | ✓ | – | ✓ | ✓ |
| Internet radio | ✓ | ✓ | – | – | ✓ | ✓ |
| Audio podcast | ✓ | ✓ | – | – | ✓ | ✓ |
| Youtube (audio) | ✓ | ✓ | – | – | – | ✓ |

✓ = Supported

✓ = Supported and recommended for the best audio quality and streaming stability.

2. Can I stream audio output from Youtube, Netflix and other media contents to LS50 Wireless II?

- Depending on the service, you can stream through AirPlay, Chromecast or Bluetooth.

3. Is the subwoofer output mono or stereo?

- The output is mono.

4. How should I set the speakers if I prefer to adjust the volume on an external equipment (preamplifier, streamers/multi-room systems) rather than through the KEF Connect App?

- In the KEF Connect App:
 - 1) In Settings, go to “Volume”, change “Volume Display” to “-/+”
 - 2) Select the relevant source input.
 - 3) Change the volume to 71. The source selection is now set to “Unity gain”.

17.3 Troubleshooting

1. What should I do to set up LS50 Wireless II to another network?

- A factory reset is necessary. This will clear the previous network settings and all EQ and system preferences. For this purpose, press and hold the Reset button (R) on the back panel until the LED light above the button blinks.

2. What should I do if I cannot find my LS50 Wireless II in the network during set-up?

- Wait for about 30–40 seconds for the speakers to be visible on the speaker list.
- If you still cannot see the speakers, make sure your mobile device, the speakers and the router are within line of sight (the closer the better).
- The speakers broadcast on Channel 2 (2.4 GHz band). If your router overlaps this channel, it may cause issues with discoverability and connection. Go to your router settings and configure the 2.4 GHz channel to avoid overlapping with Channel 2.

3. How do I report a bug or an issue?

- In the KEF Connect App, go to “Settings” > “Support”. To let us better understand the bug or issue, please provide a descriptive report.

4. There is no sound from both speakers.

- Check if the speakers are already turned on and not muted.
- Make sure you are playing the correct set of speakers and have selected the correct sound source.
- Check the volume level, you may need to turn up the volume.

5. There is dropout from both speakers.

- Check if there is a network problem or you need to set up the speakers to a less crowded router channel.
- Change the [audio streaming quality](#) in the KEF Connect App.

6. There is no sound from the Secondary Speaker.

- Make sure the Secondary Speaker is connected to power.
- Check if the connection between the two speakers is lost (Source and Volume Down buttons on the top panel of the Primary Speaker are blinking).

If the connection is lost, short press the P/S pairing button (P) on the back panel of the Primary Speaker to re-establish the connection. Wait a while until the connection is established. **Note:** Do not press the button for more than 1 second.

- If the problem persists, connect the speakers with the inter-speaker cable and turn on Cable Mode in the KEF Connect App.

7. There is dropout from the Secondary Speaker.

- If the speakers are connected wirelessly, try to move them closer to each other.
- If the problem persists, connect the speakers with the inter-speaker cable and turn on Cable Mode in the KEF Connect App.

8. The audio is out of sync with the picture when using LS50 Wireless II with a TV.

- If available, try the video delay/lip sync function of your TV.

9. I have connected the speakers to the TV with an HDMI cable, why is there no sound?

- Make sure the source is switched to TV for the speakers.
- Check the TV icon on the top panel of the Primary Speaker.

If the TV icon is blinking, the HDMI connection is not found. In this case, make sure that the HDMI cable is connected to the eARC or ARC port of the TV.

If the TV icon is pulsing (fade in/fade out), only CEC (not ARC) connection is established (TV may respond without sound). In this case, do the following:

- The HDMI CEC connection needs to be enabled on the TV. As manufacturers may name this connection differently (e.g. Anynet+ for Samsung, Simplink for LG), please check the user manual of your TV on how to turn on HDMI connection for your TV. Once the HDMI CEC connection is enabled, the TV icon on the top panel should turn solid (both CEC and ARC connections are now established).
- If there is only no sound but everything else is working, please make sure that the audio output of HDMI is set to PCM (this is often set to Dolby Digital by default). As the settings menu of each TV manufacturer is different, please refer to the user manual of your TV.
- For HDMI eARC input, make sure the connecting HDMI cable is of high speed with Ethernet to provide sufficient bandwidth and speed.
- Change the HDMI cable (our internal tests found that HDMI cables of lower quality may not be able to establish the connection).
- If the problem persists, please report the issue in the Support section of the KEF Connect App for investigation. In the meantime, use the Optical connection as a fall-back solution.

10. I have connected the speakers to the TV with an optical cable, why is there no sound?

- Make sure your TV is set to output digital audio in PCM format.
- If the problem persists, try a different optical cable or connection option (e.g. HDMI).

11. I cannot find a radio station or podcast in the KEF Connect App.







- We are constantly updating and expanding our database for radio stations and podcasts. Please use the Support function in the KEF Connect App and send us the RSS link of the website. After verification, we will add it to our database.



12. I cannot adjust the speaker volume.

- Check if you have set a maximum level for volume adjustment.
- Check if you are connecting and controlling the correct set of speakers in the network.

17.4 LED Indicators

The connection and operation status can be checked through the colours and patterns of the LED indicators on the top panel of the Primary Speaker.

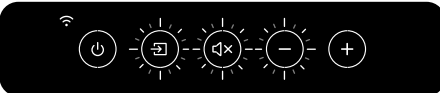
| LED indicator | Status |
|--|--|
|  | The speakers are trying to connect to a Wi-Fi network. Wi-Fi icon is blinking white and amber. |
|  | The speakers are connected to a Wi-Fi network. Wi-Fi icon is solid white. |
|  | The speakers are unable to connect to a Wi-Fi network. Wi-Fi icon is blinking amber slowly. |
|  | Bluetooth discovery mode – The speakers are ready to pair with a Bluetooth device. Bluetooth icon is pulsing. |
|  | The speakers are muted. Mute button is blinking. |
|  | TV mode is selected but HDMI cable is not connected. TV icon is blinking. |

| LED indicator | Status |
|---|---|
|  <p data-bbox="135 277 507 336">Source button and Volume Down button are blinking.</p> | <p data-bbox="557 172 997 325">The Primary Speaker cannot find the Secondary Speaker wirelessly. Short press the P/S pairing button (P) on the back panel of the Primary Speaker to re-establish connection.</p> |
|  <p data-bbox="135 469 507 528">Source button, Mute button and Volume Down button are blinking.</p> | <p data-bbox="557 363 1020 517">Cable Mode is enabled but the connection between the speakers is not established. Connect the inter-speaker cable to the Primary/Secondary connection ports (T) on the speakers.</p> |
|  <p data-bbox="98 660 546 719">Source button and Volume Down button are blinking alternately.</p> | <p data-bbox="557 587 1023 676">Firmware update is in progress. Do not unplug the power cables until the firmware update is completed.</p> |
|  <p data-bbox="98 852 546 911">Source button and Volume Down button are blinking slowly.</p> | <p data-bbox="557 746 1001 805">Firmware update failed. Do not press the Reset button (R) on the Primary Speaker:</p> <ol data-bbox="572 815 972 1070" style="list-style-type: none"> <li data-bbox="572 815 938 874">1. Pull the power cables from both speakers. <li data-bbox="572 890 938 922">2. Wait approximately 60 seconds. <li data-bbox="572 938 972 997">3. Plug the power cables back to both speakers. <li data-bbox="572 1013 1001 1070">4. Perform the firmware update again on the KEF Connect App. <p data-bbox="557 1091 1028 1150">If the problem persists, please contact your KEF dealer.</p> |

| LED indicator | Status |
|---|--|
|  <p data-bbox="124 279 518 339">TV icon, OPT icon and Mute button are blinking.</p> | <p data-bbox="557 161 815 188">There is a system error.</p> <ol data-bbox="572 204 1001 384" style="list-style-type: none"> <li data-bbox="572 204 936 264">1. Pull the power cables from both speakers. <li data-bbox="572 280 932 308">2. Wait approximately 30 minutes. <li data-bbox="572 323 1001 384">3. Plug the power cables back to both speakers to resume normal operation. <p data-bbox="557 403 1025 464">If the problem persists, please contact your KEF dealer.</p> <p data-bbox="557 483 966 608">Note: System error may occur with improper power connections. Do not use a socket/outlet extender with the speakers.</p> |

18. Appendix

18.1 Specifications

| | |
|---|---|
| Model | LS50 Wireless II |
| Drive units | Uni-Q Driver Array: LF: 130 mm (5.25 in.) aluminium cone HF: 25 mm (1 in.) vented aluminium dome with Metamaterial Absorption Technology [#] |
| Frequency range (-6 dB) measured at 85 dB/1 m | 40 Hz – 47 kHz (Depends on EQ settings) |
| Frequency response (± 3 dB) measured at 85 dB/1 m | 45 Hz – 28 kHz (Depends on EQ settings) |
| Amplifier output power (per speaker) | LF: 280 W HF: 100 W |
| Amplifier class (per speaker) | LF: Class D HF: Class AB |
| Max SPL measured at 1m | 108 dB |
| Wireless streaming features | AirPlay 2 Google Chromecast ROON Ready UPnP Compatible Bluetooth 4.2 |
| Streaming services | Spotify via Spotify Connect Tidal Amazon Music Qobuz Deezer QQ Music via QPlay Internet Radio Podcast (Depends on services availability in different countries) |
| Source resolution | Network up to 384 kHz/24 bit Optical up to 96 kHz/24 bit Coaxial up to 192 kHz/24 bit HDMI up to 192 kHz/24 bit (Depends on source resolution) |
| Interspeaker connection | Wireless: all sources resampled to 96 kHz/24 bit PCM Wired: all sources resampled to 192 kHz/24 bit PCM |

| | |
|---------------------------------------|--|
| Supported format (all inputs) | MP3, M4A, AAC, FLAC, WAV, AIFF, ALAC, WMA, LPCM and Ogg Vorbis |
| Supported format (network) | MQA DSF: DSD64, DSD128, DSD256 DFF: DSD64 |
| Dimensions (H x W x D per speaker) | 305 x 200 x 311 mm (12.0 x 7.9 x 12.2 in.) |
| Weight (per set) | 20.1 kg (44.31 lbs) |
| Power input | 100–240 VAC 50/60 Hz |
| Power consumption | 200 W (operating power) < 2.0 W (standby power) |

| | Primary Speaker | Secondary Speaker |
|------------------------------|---|--|
| Inputs | HDMI eARC TOSLINK Optical Digital Coaxial Analog 3.5 mm Auxiliary USB Type A (service) RJ45 Ethernet (network) RJ45 Ethernet (interspeaker) | USB Type A (service) RJ45 Ethernet (interspeaker) |
| Output | RCA Subwoofer output | RCA Subwoofer output |
| Wi-Fi network standard | IEEE 802.11a/b/g/n/ac IPv4, IPv6 | – |
| Wi-Fi network frequency band | Dual-band 2.4 GHz / 5 GHz | – |

*Metamaterial Absorption Technology is a joint development with Acoustic Metamaterials Group

Wireless performance depends on many factors, including network traffic, distance from access point, room materials and construction, interference and other adverse conditions.

For further information and troubleshooting, please visit the KEF website: KEF.COM

KEF reserves the right, in line with continuous research and development, to amend or change specifications without prior notice. E. & O.E



The Bluetooth word mark and logos are registered trademarks owned by Bluetooth SIG, Inc.



Amazon Music is a registered trademark of Amazon.com Inc.



Apple and AirPlay are registered trademarks of Apple Inc., registered in the U.S. and other countries.



Deezer is a registered trademark of Access Industries.



Google Play store and Chromecast are registered trademarks of Google LLC.



Qobuz is a registered trademark of Xandrie SA.



QQ Music is a registered trademark of Tencent Music Entertainment Group (TME).



ROON is a registered trademark of Roon Labs LLC or Roon Labs's licensors.



Spotify is a registered trademark of Spotify AB.



TIDAL is a registered trademark of Aspiro AB.

18.2 Explanation of symbols

18.2.1 Warning Symbols



The lightning flash with arrowhead symbol, within an equilateral triangle, is intended to alert the user to the presence of uninsulated “dangerous voltage” within the products enclosure that may be of a sufficient magnitude to constitute a risk of electrical shock to persons.



The exclamation mark within an equilateral triangle is intended to alert the user to the presence of important operating and maintenance (servicing) instructions in the literature accompanying the appliance.

18.2.2 Regional Symbols

Europe and North America



This marking indicates that this product should not be disposed with other household wastes throughout the EU. To prevent possible harm to the environment or human health from uncontrolled waste disposal, recycle it responsibly to promote the sustainable reuse of material resources.

To dispose of your used device, please use the proper collection system or contact the retailer where the product was purchased, they may be able to take the product for environmentally safe recycling.



Products marked with this symbol meet all applicable Community regulations for the European Economic Area.



Products bearing the cTUVus Certification Mark reflect supplier commitment and confidence and have been independently confirmed to meet the minimum requirements of US and Canadian electrical safety standards.



This FCC mark certifies that the electromagnetic interference from the device is under the limits approved by the Federal Communications Commission in the US.

Asia-Pacific



The Regulatory Compliance Mark (Australia, New Zealand) indicates that the product complies with the relevant guidelines of the ACMA as well as corresponding government requirements for the safety of electrical devices.



The symbol indicates that the product meets the specified safety requirements of Singapore Consumer Protection Registration Scheme.



The Japan PSE Mark Certification indicates that the product meets the technical requirements of the Electrical Appliance and Material Safety Law (DENAN).



These marks indicate compliance with technical and design requirements for telecommunication terminal equipment in Japan.



The Korean Certification mark indicates that the product complies with Korea's product safety requirements for electrical and electronic equipment.



The China Compulsory Certificate mark indicates that the product meets the safety requirements of the Chinese national standards (Guobiao).



The product is only suitable for use in areas under 2,000 m above sea level (China).



RoHS (China): This product contains certain hazardous substances and can be used safely during its environmental friendly use period (10 years). The product should enter into the recycling system after its environmental friendly use period.



RoHS (Taiwan): This symbol means that the product does not exceed the specified concentration limits for specific hazardous substances.



The product obtained the certification from the Taiwan National Communications Commission (NCC) for low-power radio frequency appliances.



This MCMC certification mark indicates that a communications device is certified for compliance to standards according to the Communications and Multimedia (Technical Standards) Regulations 2000 in Malaysia.



Products bearing this mark is a proof that the product has been approved by the United Arab Emirates (UAE) Federal Government through Emirates Authority for Standardization and Metrology (ESMA).

18.3 IR Command Codes

LS50 Wireless II works with universal programmable remote control provided that the remote control manufacturers have implemented KEF IR command codes in their remote controls.

The following table lists the command codes required.

| | |
|----------------------|------|
| Code Format: | NEC |
| Factory Code: | 0x01 |

| | Functions | Function codes |
|----|----------------------|----------------|
| 1 | Power on/off toggle | 0x40 |
| 2 | Mute/un-mute toggle | 0x20 |
| 3 | Play/Pause | 0x18 |
| 4 | Forward | 0x52 |
| 5 | Next source | 0x58 |
| 6 | Volume up | 0x60 |
| 7 | Volume down | 0xA0 |
| 8 | Backward | 0xD2 |
| 9 | Power ON | 0x38 |
| 10 | Power OFF | 0x3A |
| 11 | Mute | 0x48 |
| 12 | Un-mute | 0x4A |
| 13 | Source: Wi-Fi | 0x30 |
| 14 | Source: Bluetooth | 0x2A |
| 15 | Bluetooth pairing | 0x98 |
| 16 | Source: AUX | 0x02 |
| 17 | Source: Optical | 0x0A |
| 18 | Preset volume (30 %) | 0x78 |
| 19 | Source: HDMI | 0x88 / 0x8A |
| 20 | Source: Coaxial | 0xE0 |
| 21 | Previous source | 0xD0 |

For more support, please visit [kef.com](https://www.kef.com)