

EDGE W

Manual Generated: 21/07/2023 - 11:48

Table of Contents

EDGE W	3
Introduction	4
What's included with the EDGE W?	5
Front panel	6
Rear panel connections	7
Getting connected	9
Power syncing	13
Protection circuitry	14
Troubleshooting	15
Technical specifications	16
Frequently Asked Questions (FAQ)	17

EDGE W

Last updated: August 9, 2022 05:05. Revision #7619



Users Manual

Introduction

Last updated: August 9, 2022 05:04. Revision #7628

This guide is designed to make installing and using this product as easy as possible. Information in this document has been carefully checked for accuracy at the time of printing; however, Cambridge Audio's policy is one of continuous improvement, therefore design and specifications are subject to change without prior notice.

This document contains proprietary information protected by copyright. All rights reserved. No part of this manual may be reproduced by any mechanical, electronic or other means, in any form, without prior written permission of the manufacturer. All trademarks and registered trademarks are the property of their respective owners.

© Copyright Cambridge Audio Ltd 2022.

For upcoming news on future products, software updates and exclusive offers, make sure you register your product at <https://www.cambridgeaudio.com/register>

What's included with the EDGE W?

Last updated: August 9, 2022 05:05. Revision #7627

Inside the box of your EDGE W you will receive:

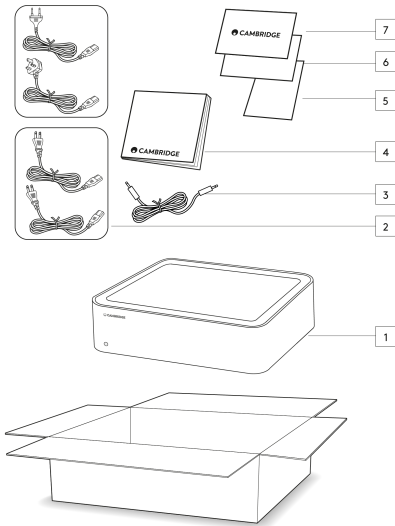

1. EDGE W Power Amplifier
2. UK power cord (Depending on which country the EDGE W was purchased in)
EU power cord (Depending on which country the EDGE W was purchased in)
CU power cord (Depending on which country the EDGE W was purchased in)
JP power cord (Depending on which country the EDGE W was purchased in)
3. Link Cable
4. User Manual
5. Warranty Card
6. Welcome Letter
7. Unboxing Card

Front panel

Last updated: August 9, 2022 05:05. Revision #7626

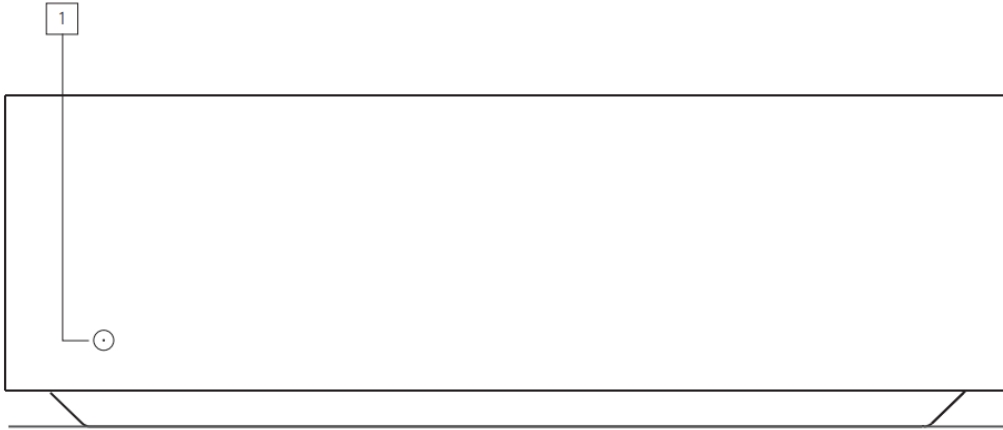

1. STANDBY/ON - Switches the unit between Standby mode (indicated by dim LED) and On (indicated by bright LED). Standby mode is a low power mode where the power consumption is less than 0.5 Watts.

AUTO POWER DOWN (APD)

The product will automatically switch to standby mode after inactivity of 20 minutes. To enable or disable this function, use the APD switch located on the rear of the unit.

Rear panel connections

Last updated: August 9, 2022 05:05. Revision #7625

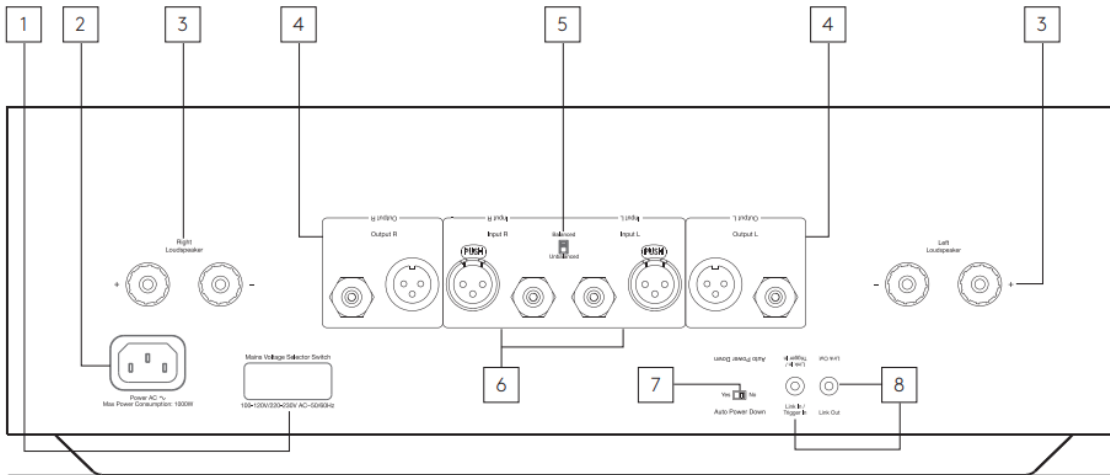

1. VOLTAGE SELECTOR SWITCH

Note: For use by Cambridge Audio service personnel only!

2. AC POWER SOCKET

3. SPEAKER TERMINALS

Note: When using a banana plug, make sure the speaker terminals are completely tightened before inserting the plug.

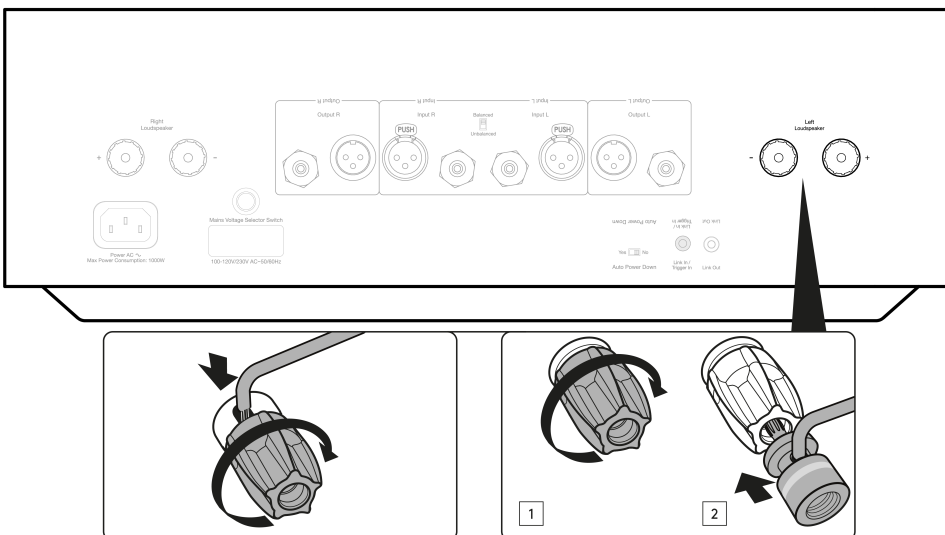

Connect the wires from your left channel loudspeaker to the left positive and negative terminals and the wires from the right channel loudspeaker to the right positive and negative terminals.

In each case, the red terminal is the positive output and the black terminal is the negative output.

Care should be taken to ensure no stray strands of wire short the speaker outputs together. Please ensure that the loudspeaker terminals have been tightened completely to provide a good electrical connection.

It is possible for the sound quality to be affected if the screw terminals are loose.

4. LOOP OUT - This output can be used for bi-amping, daisy chaining or connecting to the input of an active subwoofer.

The XLR output is balanced and the RCA output is unbalanced.

5. BALANCED/UNBALANCED SWITCH - Select depending on whether a source is connected to the balanced XLR or unbalanced RCA input.

Note: There will be no sound from the amp if the correct input isn't selected. If a source is connected to the balanced input, for example, ensure that the balanced switch has been selected.

6. BALANCED/UNBALANCED INPUTS - The XLR input is balanced and the RCA input is unbalanced.

7. AUTO POWER DOWN (APD) SWITCH - Switches to enable or disable the Auto Power Down function. When enabled, the amplifier will automatically switch to standby mode after inactivity of 20 minutes.

8. LINK - Refer to the 'Power syncing' section of this manual for more information.

Getting connected

Last updated: August 9, 2022 05:05. Revision #7624

LOUDSPEAKERS

Check the impedance of your speakers. You can use types with an impedance of between 4 and 8 Ohms.

The red coloured speaker terminals are positive (+) and the black speaker terminals are negative (-). Make sure the correct polarity is maintained at each speaker connector or the sound can become weak and “phasey” with little bass.

USING BARE WIRE CONNECTIONS

Prepare the speaker cords for connection by stripping off approximately 10mm (3/8”) or less of the outer insulation. More than 10mm could cause a short circuit. Twist the wires tightly together so there are no loose ends. Unscrew the speaker terminal, insert the speaker cable, tighten the terminal and secure the cable.

Note: All connections are made using standard loudspeaker cable.



USING BANANA PLUGS

We recommend using Banana plugs with our units to establish a secure connection and ensure there are no loose strands of wire that may cause unwanted noise or interference.

Once you have stripped the outer insulation of the cable and twisted the wires as indicated below, securely connect these to your banana plugs and push the plug in as far as possible without applying excessive force.

Note: When using a banana plug, make sure the speaker terminals are completely tightened before inserting the plug.

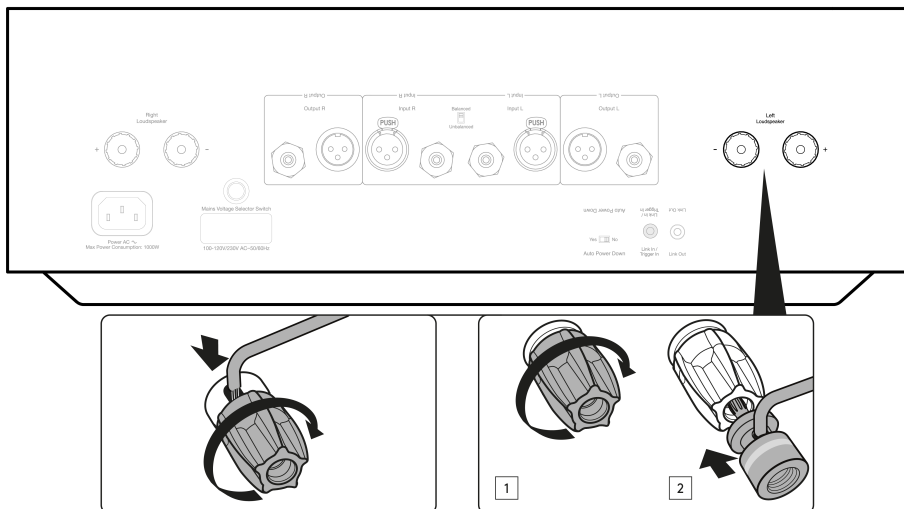

BASIC CONNECTIONS

The analogue inputs are to be connected to the Pre-Outs of a Preamplifier or Integrated amp. The diagrams below show the basic connection from a Preamplifier.

Unbalanced input:

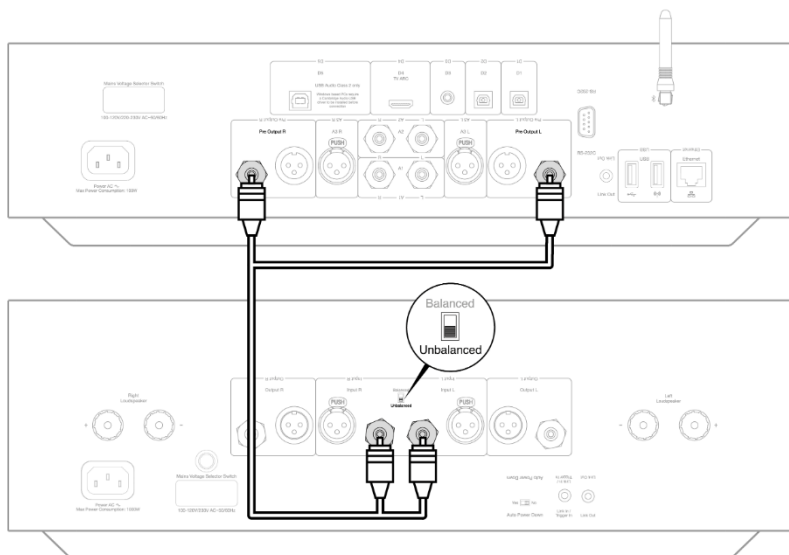

Using RCA cables will enable an unbalanced analogue connection to your EDGE W.

If using RCA cables, ensure the 'Unbalanced' switch on your EDGE W is selected.

Balanced input:

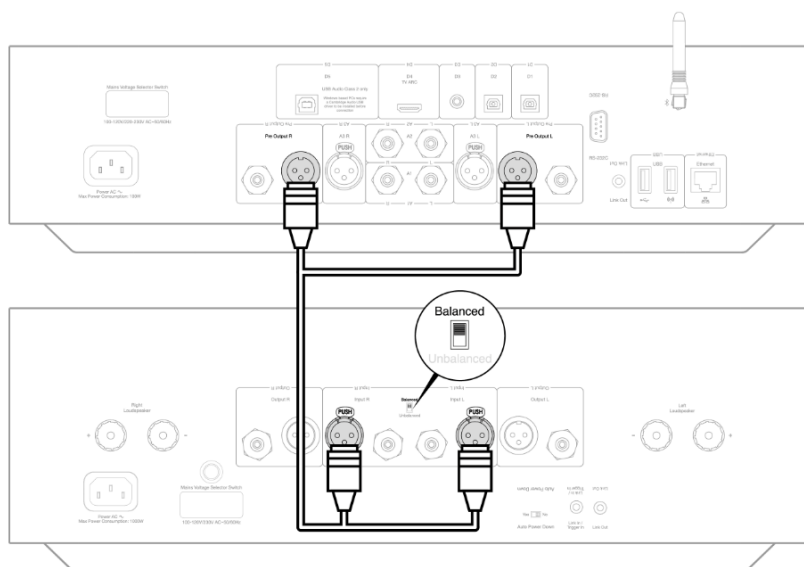

Using XLR cables will enable a balanced analogue connection to your EDGE W. This will provide a cleaner signal path compared to an RCA unbalanced connection, especially over longer cable lengths, however the increase in audio quality they provide is subjective when used over shorter lengths.

If using XLR cables, ensure the 'Balanced' switch on your EDGE W is selected.

ANALOGUE OUTPUTS

The output connections remain active at all times which means there are a few uses for these connections that can enable you to get even more from your system.

Any component or device connected to the EDGE W's outputs will follow the volume commands of the preamplifier, to ensure the volume increases/decreases in sync.

Subwoofer:

Although the EDGE W does not contain a dedicated subwoofer output, a subwoofer can be connected from either of the unbalanced RCA Pre-Outputs to the corresponding inputs on the rear of your powered sub.

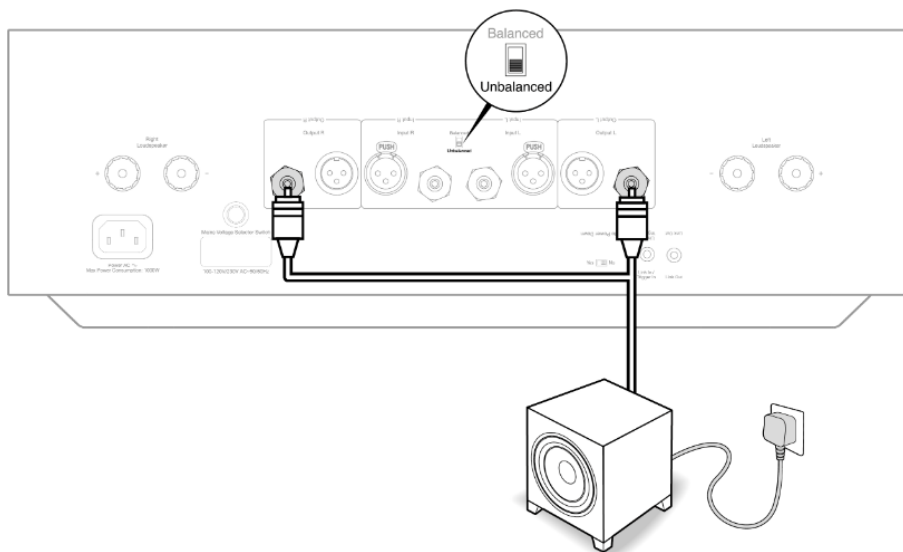

BI-AMPING

Bi-amping allows you to drive the high and mid frequencies of your speakers from one power amp, and the low frequencies of your speakers from a second power amp.

The diagram below shows how to bi-amp a pair of EDGE W's connected to an EDGE NQ using a balanced connection.

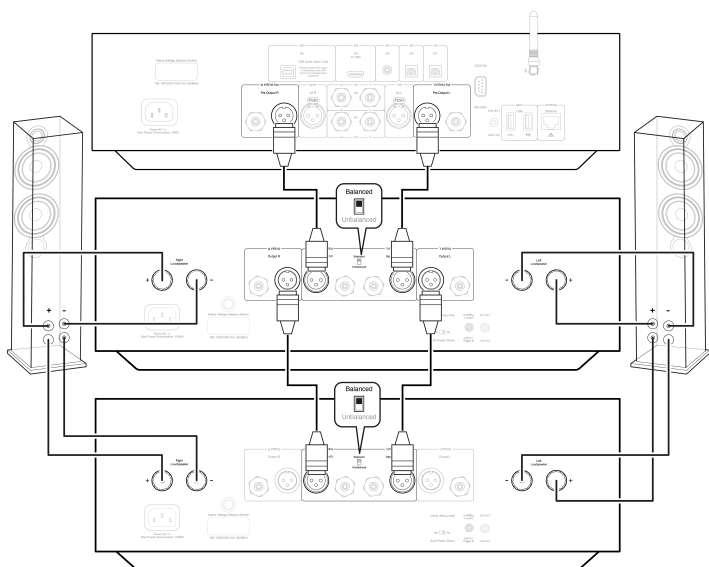

Power syncing

Last updated: August 9, 2022 05:05. Revision #7623

Use the Link wire between the EDGE NQ and EDGE W or EDGE A and EDGE W to synchronise power on/standby. When you turn the EDGE A or NQ On/Off, the EDGE W will also turn On/Off.

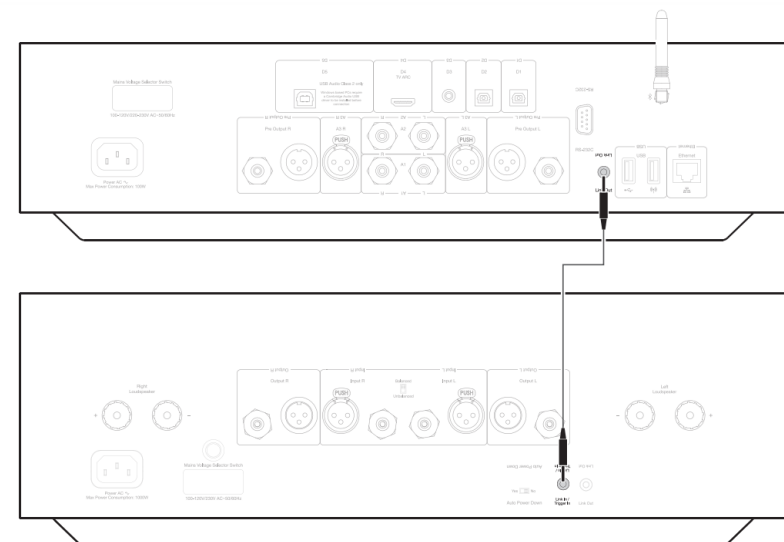

TRIGGER IN

The EDGE W can also be connected to the trigger control output of home automation equipment to control the power state of the EDGE W. The input level should be between 5V and 12V.

Protection circuitry

Last updated: November 11, 2022 10:49. Revision #7744

The EDGE W includes Amplifier Protection Circuitry to detect faults with Over Temperature, DC and Over Current. If any of these faults are detected the LED standby button will turn red.

Over Temperature

Over temperature is caused by a combination of high listening levels and low impedance speakers. The Edge W includes temperature detection which constantly monitors the heat generated by the output transistors.

If the monitored temperature reaches a high level (suitably within the limits of the output devices) the amplifier will automatically switch into a fault mode To protect itself from damage.

If the loudspeaker impedance is low the temperature of the amplifier may rise faster as the amplifier is working harder. If the amplifier is mounted in a cabinet or the ventilation slots are obstructed the over temperature detection may activate/reactivate after a short listening time.

Remedy - Leave the unit for 15 minutes to cool down before pressing the Standby button to resume normal operation. If the unit has not fully cooled down then the temperature may reach the limit soon after the amplifier is powered up.

DC

EDGE W offers loudspeaker protection if the output of the amplifier goes to a high constant voltage (DC) because of some internal fault. This is a rare fault, although detecting it will protect your loudspeakers from damage.

Remedy - Due to the necessary sensitivity of the DC protection circuit, extremely hard clipping of the amplifier may cause DC protection to be triggered. If this fault occurs, please contact your dealer for service or our support team <https://www.cambridgeaudio.com/gbr/en/contact>.

Over Current

EDGE W offers V/I (voltage/current) protection by constantly monitoring the output transistors to keep them working inside their Safe Operating Area (SOA). The SOA is a set of limits given by the output transistor manufacturer to ensure reliability. The V/I protection has been incorporated within the amplifier circuitry to provide a fast response to temporary overload conditions. When the V/I protection is triggered the unit will continue to operate but distortion may be heard as the unit protects the output transistors.

Remedy - Reduce the volume. If distortion is still present, check the speaker connections and impedance ratings.

Troubleshooting

Last updated: August 9, 2022 05:05. Revision #7621

There is no power

- Ensure the AC power cord is connected securely.
- Ensure the plug is fully inserted into the wall socket and is switched on.
- Check fuse in the mains plug or adaptor.

There is no sound

- Make sure the unit is not in Standby mode.
- Check that source component is properly connected.
- Check that your speakers are properly connected.
- Ensure that the correct input has been selected via the Balanced/Unbalanced switch.
- If possible, use different interconnect cables and speaker cables.
- Check your source devices' volume control to ensure this is not muted.
- Check with alternative source device.

There is no sound on one channel

- Check speaker connections.
- Check interconnects.

There is weak bass or diffused stereo imaging

- Ensure that speakers are not wired out of phase.

There is a loud buzz or hum

- Ensure no interconnects are loose or defective.

The LED standby button is red

- Check the 'Protection Circuitry' section for troubleshooting steps.

Technical specifications

Last updated: August 9, 2022 05:05. Revision #7620

Continuous power output:

- 100W RMS into 8 Ohms
- 200W RMS into 4 Ohms

THD (unweighted):

- <0.002% 1kHz at rated power (8 Ohms)
- <0.02% 20Hz - 20kHz at rated power (8 Ohms)

Frequency Response:

<3Hz - >80kHz +/-1dB

S/N ratio (ref 1W into 8 Ohm):

>93 dB

Crosstalk @ 1kHz:

< -100dB

S/N ratio (ref full power):

>113 dB

Input sensitivity:

Input A1-A2 (unbalanced) 1.09V RMS.

Input impedances:

- Input A3 (balanced) 47k Ohm Input
- A1-A2 (unbalanced) 47k Ohm

Inputs:

Balanced, Unbalanced

Outputs:

Speakers, Loop out

Max power consumption:

1000W

Standby power consumption:

<0.5W

Dimensions:

150 x 460 x 405mm (5.9 x 18.1 x 15.9")

Weight:

23.6kg (51.9lbs)

Frequently Asked Questions (FAQ)

Last updated: August 9, 2022 05:05. Revision #7629

What impedance speakers can I use with the EDGE W?

You can use speakers with an impedance between 4-8 Ohms with the EDGE W. The EDGE W outputs 100W RMS into 8 Ohms and 200W RMS into 4 Ohms.

What amplification class does the EDGE W use?

The EDGE W uses Class XA amplification. For Class XA, the crossover point is moved so that both sets of transistors are always on until the signal reaches a loud enough level.

This means that for low level signals, the amplifier is essentially operating as a Class A amplifier and it is only when the signal is sufficiently loud enough that the transistors switch over. Any crossover distortion is therefore masked within the signal.