

# Ci160QS



## Architectural Speaker

### Product Overview

The KEF Ci160QS is a premium high performance speaker designed for in-ceiling and flush mount installations where a square shaped assembly is preferred. It's a coincident point source design featuring KEF's proprietary "sit-anywhere" Uni-Q® technology with a driver array that includes a 19mm high frequency aluminium dome tweeter mounted in the acoustic centre of the 160mm low frequency woofer. The tweeter features KEF's Tangerine Waveguide engineered to enhance high frequency dispersion and when combined with the Uni-Q array, creates a speaker that delivers exceptionally smooth and consistent coverage across a wide listening area. The KEF Ci160QS is constructed using weather resistant components and the Ultra-Thin Bezel and grille are treated with a UV protective finish making this speaker ideal for hi-fidelity applications in premium commercial venues such as luxury hotels, conference centres, and restaurants.



### Key Features

**KEF "sit-anywhere" Uni-Q® Technology** – This proprietary driver array places the tweeter in the acoustic centre of the woofer delivering wide dispersion with consistent sound characteristics throughout the space. Because the high and low frequencies originate from the same point, acoustic lobing problems common to other speaker designs are virtually eliminated allowing fewer speakers to deliver smooth coverage across a wide listening area.

**Tangerine Waveguide** – In addition to protecting the driver, the Tangerine Waveguide further enhances dispersion allowing for 125 degrees of coverage.

**Weather Resistant** – Manufactured using a proprietary plating and powder coating process, the KEF Ci160QS is UV protected and designed to withstand the harshest operating environments.

**Ultra-Thin Bezel (UTB)** – To maintain a premium aesthetic appearance, the ABS bezel was carefully engineered to be as thin as possible while maintaining the necessary structural rigidity.

**Magnetic Grille** – For security and ease of installation the grille attaches by a powerful magnetic circuit and can be painted to match any décor.

**IP64 Certification** – The speaker passed official IEC testing to ensure that splashing water would have no harmful effects on assembly components.

### Architect and Engineer Specifications

The speaker shall be designed for in-ceiling flush mount installations and utilise a coincident point source design with the high frequency tweeter mounted in the acoustic centre of the low frequency woofer. The driver array shall be mounted in a square shaped assembly.

The speaker shall consist of a 160mm low frequency woofer and a vented 19mm aluminium dome high frequency tweeter featuring a waveguide for improved dispersion mounted in a UV protected ABS baffle with a paintable bezel of no more than 5mm in width. The grille shall also be paintable, include a paint shield, and attach by a powerful magnetic circuit for ease of installation and security. The speaker design shall be open back and deliver a minimum frequency response of 38Hz-34kHz +/- 6 dB. The speaker shall not weigh more than 1.9kg and be available with a rough in frame kit.

The nominal impedance of the speaker shall be 8 ohms and it must achieve a minimum pressure sensitivity of 89 dB SPL at 1 meter on-axis with an input of 2.83 volts. The crossover frequency between the woofer and tweeter shall be 3.0kHz. The speaker shall meet numerous safety and performance standards listed by regulatory bodies around the world.

The speaker shall be the KEF Ci160QS.

## Architectural Speaker

---

### Specifications

Model		Ci160QS
Series		Q Series
Nominal impedance		8Ω
Sensitivity (2.83V/1m)		89dB
Frequency response (±6dB) open-backed		38Hz - 34kHz
Nominal coverage		125°
Max SPL		105dB
Crossover frequency		3.0kHz
Drive units	LF	160mm (6.5in.) Uni-Q
	MF	-
	HF	19mm (0.75in.)
Recommended amplifier power		10 - 125 W
Recommended high-pass filter		45Hz
Product external dimensions (H x W x D)		223 x 223 x 97 mm (8.78 x 8.78 x 3.82in.)
Cut-out dimensions (H x W)		190 x 190mm (7.48 x 7.48in.)
Mounting depth from surface		91mm (3.58in.)
Net Weight		1.88kg (4.14lbs.)
Optional rough in frame		RIF160S
Optional rear enclosure		RNC160S
Ideal rear volume		25L
Minimum rear volume		15L

Visit [KEF.COM](http://KEF.COM) for more about KEF and its products.

KEF reserves the right, in line with continuing research and development, to amend or change specifications. E&OE.

The Ci speakers that utilise THX in the model name have undergone and passed certified THX approval.

# Ci160QS



## Architectural Speaker

### Directivity Index

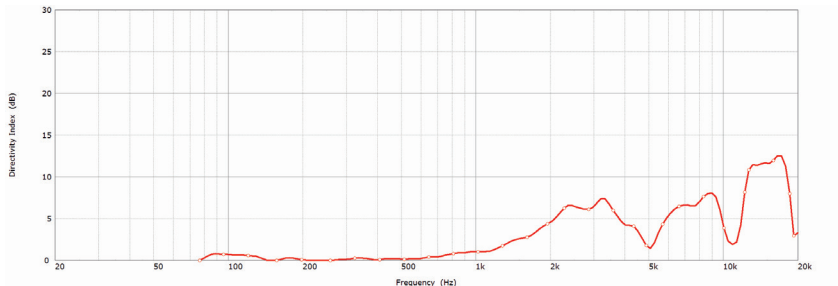

### Beamwidth -3dB

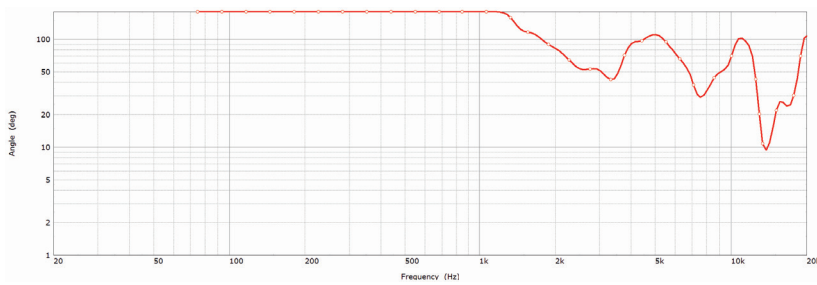

### Beamwidth -6dB

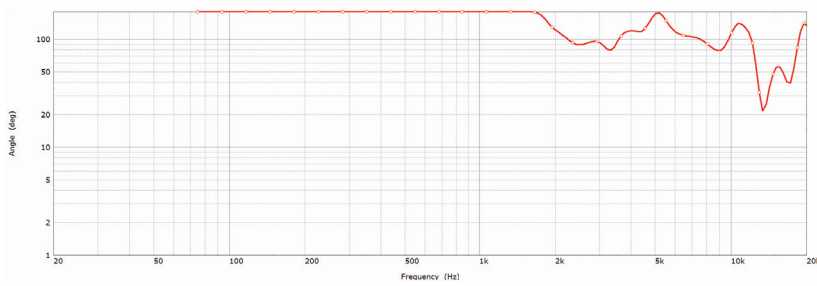

### Impedance

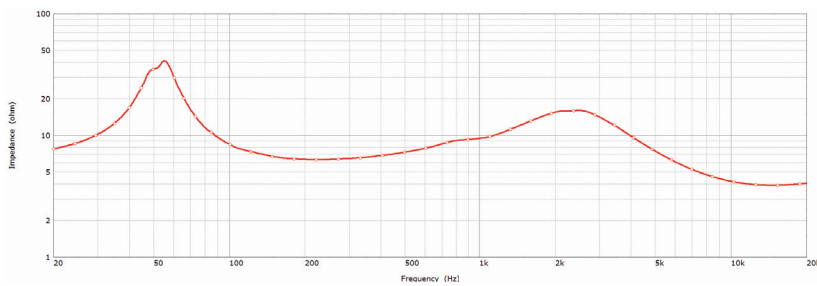

### Sensitivity (2.83V/1m)

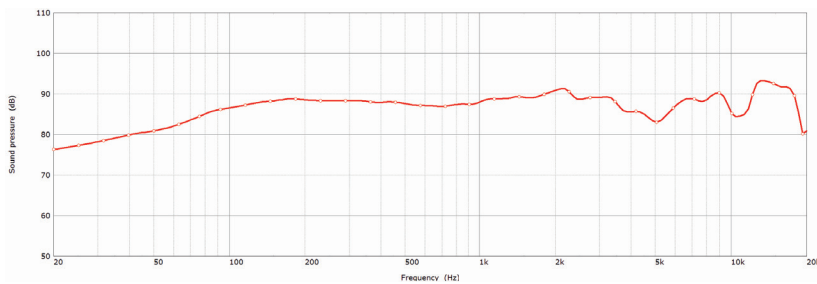

### Polar Responses

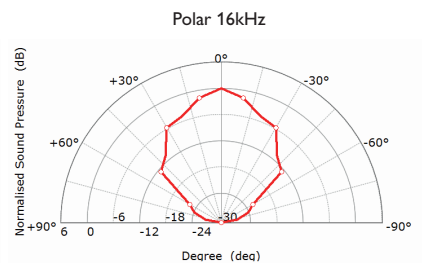
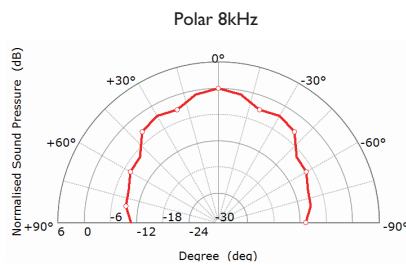
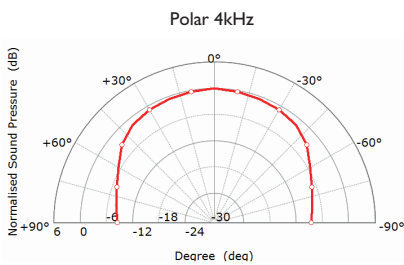
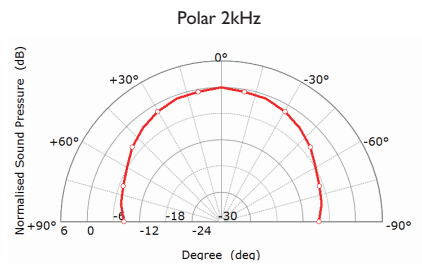
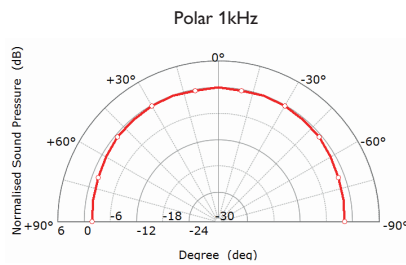
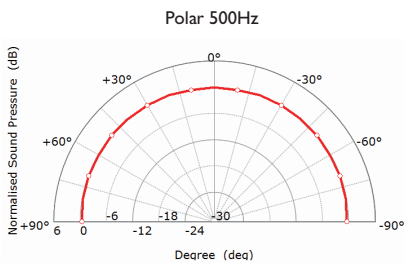
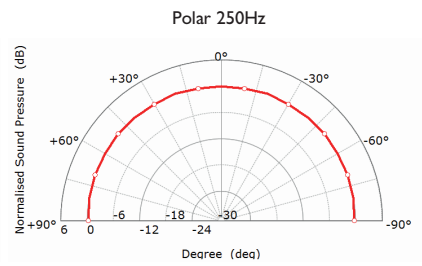
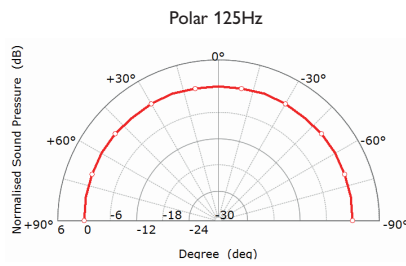
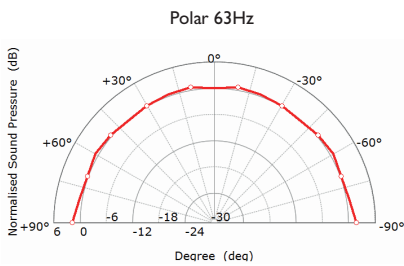

# Ci160QS



## Architectural Speaker

### Mechanical Diagrams

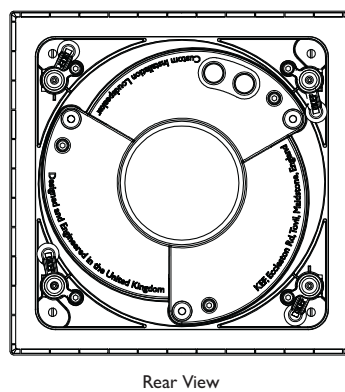
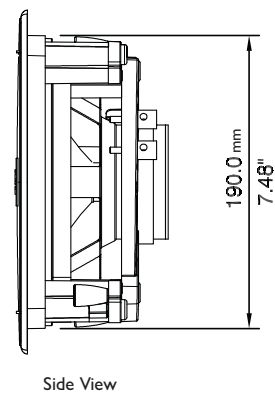
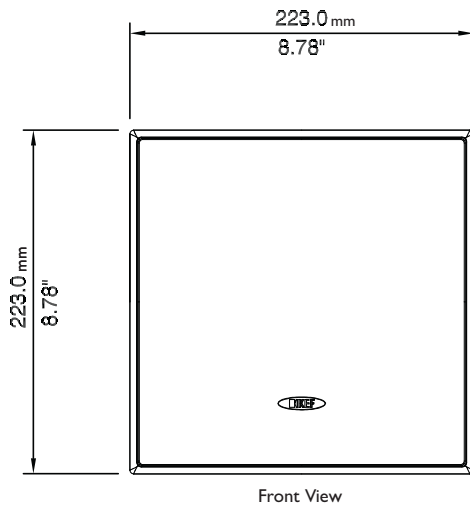
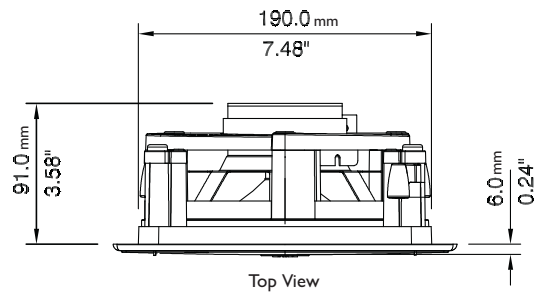

Dimensions in mm (inches)

KEF reserves the right, in line with continuing research and development, to amend or change specifications. E&OE.