



PORTABLE HOME SPEAKER

Please read and keep all safety, security, and use instructions.

CE Bose Corporation hereby declares that this product is in compliance with the essential requirements and other relevant provisions of Directive 2014/53/EU and all other applicable EU directive requirements. The complete declaration of conformity can be found at: www.Bose.com/compliance

Important Safety Instructions

1. Read these instructions.
2. Keep these instructions.
3. Heed all warnings.
4. Follow all instructions.
5. Clean only with a dry cloth.
6. Do not block any ventilation openings. Install in accordance with the manufacturer's instructions.
7. Do not install near any heat sources such as radiators, heat registers, stoves, or other apparatus (including amplifiers) that produce heat.
8. Only use attachments/accessories specified by the manufacturer.
9. Unplug this apparatus during lightning storms or when unused for long periods of time.
10. Refer all servicing to qualified personnel. Servicing is required when the apparatus has been damaged in any way, such as power-supply cord or plug is damaged, liquid has been spilled or objects have fallen into the apparatus, the apparatus has been exposed to rain or moisture, does not operate normally, or has been dropped.



Contains small parts which may be a choking hazard. Not suitable for children under age 3.



This product contains magnetic material. Consult your physician on whether this might affect your implantable medical device.

- Keep the product away from fire and heat sources. Do NOT place naked flame sources, such as lighted candles, on or near the product.
- Do NOT make unauthorized alterations to this product.
- Do NOT use a power inverter with this product.
- Do not use any charger other than that specifically provided for use with the product.



仅适用于 2000m 以下地区安全使用
Use at altitude less than 2000 meters only.

- Do not expose products containing batteries to excessive heat (e.g. from storage in direct sunlight, fire or the like).
- The product label is located on the bottom of the product.

NOTE: This equipment has been tested and found to comply with the limits for a Class B digital device, pursuant to Part 15 of the FCC Rules. These limits are designed to provide reasonable protection against harmful interference in a residential installation. This equipment generates, uses, and can radiate radio frequency energy and, if not installed and used in accordance with the instructions, may cause harmful interference to radio communications. However, there is no guarantee that interference will not occur in a particular installation. If this equipment does cause harmful interference to radio or television reception, which can be determined by turning the equipment off and on, the user is encouraged to try to correct the interference by one or more of the following measures:

- Reorient or relocate the receiving antenna.
- Increase the separation between the equipment and receiver.
- Connect the equipment into an outlet on a circuit different from that to which the receiver is connected.
- Consult the dealer or an experienced radio/TV technician for help.

Changes or modifications not expressly approved by Bose Corporation could void the user’s authority to operate this equipment.

This device complies with part 15 of the FCC Rules and with ISED Canada license-exempt RSS standard(s). Operation is subject to the following two conditions: (1) This device may not cause harmful interference, and (2) this device must accept any interference received, including interference that may cause undesired operation.

This equipment should be installed and operated with a minimum distance of 20 cm between radiator and your body.

This device for operation in the band 5150 – 5250 MHz is only for indoor use to reduce the potential for harmful interference to other co-channel systems.

CAN ICES-3(B)/NMB-3(B)

The product, in accordance with the Ecodesign Requirements for Energy Related Products Directive 2009/125/EC, is in compliance with the following norm(s) or document(s): Regulation (EC) No. 1275/2008, as amended by Regulation (EU) No. 801/2013.

Required Power State Information	Power Modes	
	Standby	Networked Standby
Power consumption in specified power mode, at 230V/50Hz input	≤ 0.5 W	Wi-Fi®, Bluetooth® ≤ 2.0 W
Time after which equipment is automatically switched into mode	< 2.5 hours	≤ 20 minutes
Power consumption in networked standby if all wired network ports are connected and all wireless network ports are activated, at 230V/50Hz input	N/A	≤ 2.0 W
Network port deactivation/activation procedures. Deactivating all networks will enable standby mode.	Wi-Fi®: Deactivate by pressing and holding the Play/Pause button > and Bluetooth button ✕ simultaneously for at least 5 seconds. Repeat to activate. Bluetooth®: Deactivate by clearing the pairing list by pressing and holding the Bluetooth® button for 10 seconds. Activate by pairing with a Bluetooth source.	

For Europe:

Frequency bands of operation 2400 to 2483.5 MHz, 5150 to 5350 MHz, and 5470 to 5725 MHz.

Maximum transmit power less than 20 dBm EIRP.

Maximum transmit power is below regulatory limits such that SAR testing is not necessary and exempt per applicable regulations.

This device is restricted to indoor use when operating in the 5150 to 5350 MHz frequency range in all EU Member States listed in the table.

										
BE	DK	IE	UK	FR	CY	SK	HU	AT	SE	
BG	DE	PT	EL	HR	LV	LT	MT	PL		
CZ	EE	FI	ES	IT	RO	LU	NL	SI		

External Power Supply Technical Information

The external power supply provided with the product, in accordance with the Ecodesign Requirements for Energy Related Products Directive 2009/125/EC, is in compliance with the following norms(s) or documents(s): Commission Regulation (EU) 2019/1782.

Manufacturer	Bose Products B.V.
Commercial registration number	36037901
Address	Gorslaan 60 1441 RG Purmerend The Netherlands
Model identifier	F5V-3C-TC-WW
Input voltage	100V-240V
Input AC frequency	50Hz/60Hz
Output voltage	5V DC
Output current	3A
Output power	15W
Average active efficiency	82.3%
Efficiency at low load (10%)	76.0%
No-load power consumption	0.07W



This symbol means the product must not be discarded as household waste, and should be delivered to an appropriate collection facility for recycling. Proper disposal and recycling helps protect natural resources, human health and the environment. For more information on disposal and recycling of this product, contact your local municipality, disposal service, or the shop where you bought this product.



Please dispose of used batteries properly, following local regulations. Do not incinerate.



Removal of the rechargeable lithium-ion battery in this product should be conducted only by a qualified professional. Please contact your local Bose retailer or see products.bose.com/static/compliance/index.html for further information.

Management Regulation for Low-power Radio-frequency Devices

Article XII

According to “Management Regulation for Low-power Radio-frequency Devices” without permission granted by the NCC, any company, enterprise, or user is not allowed to change frequency, enhance transmitting power or alter original characteristic as well as performance to an approved low power radio-frequency devices.

Article XIV

The low power radio-frequency devices shall not influence aircraft security and interfere legal communications; If found, the user shall cease operating immediately until no interference is achieved. The said legal communications means radio communications operated in compliance with the Telecommunications Act.

The low power radio-frequency devices must be susceptible with the interference from legal communications or ISM radio wave radiated devices.

DON'T attempt to remove the rechargeable lithium-ion battery from this product. Contact your local Bose retailer or other qualified professional for removal.

China Restriction of Hazardous Substances Table

Names and Contents of Toxic or Hazardous Substances or Elements						
	Toxic or Hazardous Substances and Elements					
Part Name	Lead (Pb)	Mercury (Hg)	Cadmium (Cd)	Hexavalent (CR(VI))	Polybrominated Biphenyl (PBB)	Polybrominated diphenylether (PBDE)
PCBs	X	0	0	0	0	0
Metal Parts	X	0	0	0	0	0
Plastic Parts	0	0	0	0	0	0
Speakers	X	0	0	0	0	0
Cables	X	0	0	0	0	0
This table is prepared in accordance with the provisions of SJ/T 11364. O: Indicates that this toxic or hazardous substance contained in all of the homogeneous materials for this part is below the limit requirement of GB/T 26572. X: Indicates that this toxic or hazardous substance contained in at least one of the homogeneous materials used for this part is above the limit requirement of GB/T 26572.						

Taiwan Restriction of Hazardous Substances Table

Equipment name: Powered Speaker, Type designation: 429329						
Restricted substances and its chemical symbols						
Unit	Lead (Pb)	Mercury (Hg)	Cadmium (Cd)	Hexavalent chromium (Cr+6)	Polybrominated biphenyls (PBB)	Polybrominated diphenyl ethers (PBDE)
PCBs	-	o	o	o	o	o
Metal Parts	-	o	o	o	o	o
Plastic Parts	o	o	o	o	o	o
Speakers	-	o	o	o	o	o
Cables	-	o	o	o	o	o

Note 1: "o" indicates that the percentage content of the restricted substance does not exceed the percentage of reference value of presence.

Note 2: The "-" indicates that the restricted substance corresponds to the exemption.

Please complete and retain for your records

The serial and model numbers are located on the bottom of the speaker.

Serial number: _____

Model number: _____

Please keep your receipt with your owner's guide. Now is a good time to register your Bose product. You can easily do this by going to global.Bose.com/register

Date of Manufacture: The eighth digit in the serial number indicates the year of manufacture; "0" is 2010 or 2020.

China Importer: Bose Electronics (Shanghai) Company Limited, Part C, Plant 9, No. 353 North Riyang Road, China (Shanghai) Pilot Free Trade Zone

EU Importer: Bose Products B.V., Gorslaan 60, 1441 RG Purmerend, The Netherlands

Taiwan Importer: Bose Taiwan Branch, 9F-A1, No. 10, Section 3, Minsheng East Road, Taipei City 104, Taiwan
Phone Number: +886-2-2514 7676

Mexico Importer: Bose de México, S. de R.L. de C.V., Paseo de las Palmas 405-204, Lomas de Chapultepec, 11000 México, D.F. Phone Number: +5255 (5202) 3545

Electrical Ratings: 5Vdc, 3A

Security Information



This product is capable of receiving automatic security updates from Bose. To receive automatic security updates, you must complete the product setup process in the Bose Music app and connect the product to the Internet. **If you do not complete the setup process, you will be responsible for installing security updates that Bose makes available.**

Amazon, Alexa, Amazon Music, and all related logos are trademarks of Amazon, Inc. or its affiliates.

Apple, the Apple logo, and AirPlay are trademarks of Apple Inc. registered in the U.S. and other countries. App Store is a service mark of Apple Inc.

Use of the Works with Apple badge means that an accessory has been designed to work specifically with the technology identified in the badge and has been certified by the developer to meet Apple performance standards.

The *Bluetooth*[®] word mark and logos are registered trademarks owned by Bluetooth SIG, Inc. and any use of such marks by Bose Corporation is under license.

Google and Google Play are trademarks of Google LLC.

This product contains the iHeartRadio service. iHeartRadio is a registered trademark of iHeartMedia, Inc.

This product is protected by certain intellectual property rights of Microsoft. Use or distribution of such technology outside of this product is prohibited without a license from Microsoft.

Pandora, the Pandora logo, and the Pandora trade dress are trademarks or registered trademarks of Pandora Media, Inc. used with permission.

This product incorporates Spotify software which is subject to third-party licenses found here:

www.spotify.com/connect/third-party-licenses

Spotify is a registered trademark of Spotify AB.

Wi-Fi is a registered trademark of Wi-Fi Alliance[®].

Bose, Bose Portable Home Speaker, Bose Music, Bose Noise Cancelling Headphones, QuietComfort, SimpleSync, SoundLink, and SoundLink Revolve are trademarks of Bose Corporation.

Bose Corporation Headquarters: 1-877-230-5639

©2020 Bose Corporation. No part of this work may be reproduced, modified, distributed, or otherwise used without prior written permission.

To view the license disclosures that apply to the third-party software packages included as components of your Bose Portable Home Speaker product:

1. On the speaker, press and hold the Volume up button + and the Volume down button — for 5 seconds.
2. Connect a USB-C cable to the USB-C connector on the bottom of the speaker.

NOTE: If you are using the Bose Portable Home Speaker Charging Cradle to charge the speaker, make sure that the cable is connected to the USB-C port on the back of the speaker and not charging cradle.

3. Connect the other end of the cable to a computer.
4. On the computer, enter **<http://203.0.113.1/opensource>** in a browser window to display the EULA and license disclosures.

WHAT'S IN THE BOX

Contents 13

WAYS TO USE

Connected to Wi-Fi® 14
 Not connected to Wi-Fi..... 14

SPEAKER PLACEMENT

Recommendations..... 15

BOSE MUSIC APP SETUP

Download the Bose Music app..... 16

EXISTING BOSE MUSIC APP USERS

Add the speaker to an existing account..... 17
 Connect to a different Wi-Fi network..... 17
 Reconnect to a Wi-Fi network..... 17

POWER

Power on 18
 Power off..... 19
 Network standby..... 19

SPEAKER CONTROLS

Speaker functions 21
 Media playback and volume..... 21
 Voice assistant controls..... 22

VOICE ASSISTANT

Voice assistant options..... 23

Set up your voice assistant 23

Access Google Assistant..... 24

 Use your voice 24

 Use the speaker controls 25

Play music with Google Assistant 26

 Choose a default music service 26

Access Alexa..... 27

 Use your voice 27

 Use the speaker controls 28

BLUETOOTH® CONNECTIONS

Using *Bluetooth* only (No Wi-Fi) 29

Connect a mobile device 29

Disconnect a mobile device..... 30

Reconnect a mobile device..... 31

Connect an additional mobile device 31

Clear the speaker device list..... 31

STREAM AUDIO WITH AIRPLAY

Stream audio from the Control Center..... 32

Stream audio from an app 32

BATTERY

Charge the speaker 33
 Charge the speaker using the Bose Portable Home Speaker
 Charging Cradle 33
 Check the battery level..... 34

SPEAKER STATUS

Wi-Fi status 35
 Media playback and volume status 36
Bluetooth connection status 37
 Voice assistant status 38
 Google Assistant status 38
 Amazon Alexa status 39
 Microphone off light 40
 Power status 41
 Update and error status 42

ADVANCED FEATURES

Update the speaker 43
 Disable/Enable Wi-Fi 43

CONNECT BOSE PRODUCTS

Connect a Bose SoundLink *Bluetooth* speaker or Bose headphones..... 44
 Benefits..... 44
 Compatible products 44
 Connect using the Bose Music app 45
 Reconnect a Bose SoundLink *Bluetooth* speaker or Bose headphones... 45

CARE AND MAINTENANCE

Clean the speaker 46

Replacement parts and accessories..... 46

Limited warranty 46

TROUBLESHOOTING

Try these solutions first 47

Other solutions 47

Reset the speaker 52

 Restore the speaker network and audio settings 52

CONTENTS

Confirm that the following parts are included:

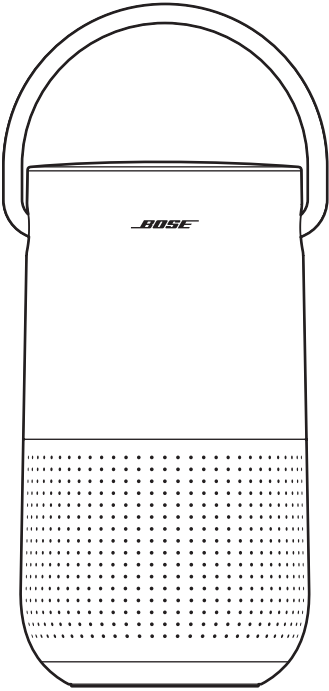

Bose Portable Home Speaker

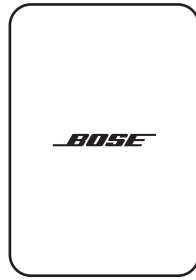

Power supply

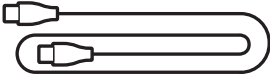

Power cord

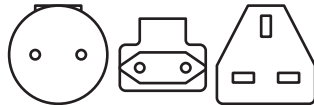

AC power adapters*

* May ship with multiple AC power adapters. Use the power adapter for your region.

NOTE: If any part of the product is damaged, don't use it. Contact your authorized Bose dealer or Bose customer service.

Visit: worldwide.Bose.com/Support/PHS

CONNECTED TO WI-FI

When connected to a Wi-Fi network, the speaker has access to all of the features including voice control, Bose Music app connectivity and music browsing, and synchronization with other speakers.

To learn more about the Bose Music app, see page 16.

NOT CONNECTED TO WI-FI

When a Wi-Fi network is unavailable, the speaker is a *Bluetooth* speaker. *Bluetooth* wireless technology lets you stream music from mobile devices such as smartphones, tablets, and laptop computers.

To connect a device to the speaker using *Bluetooth* technology, see page 29.

RECOMMENDATIONS

- Do NOT place the speaker on top of audio/video equipment (receivers, TVs, etc.), or any other object that may generate heat. Heat generated by these items may result in poor speaker performance.
- Do NOT place any objects on top of the speaker or in front of the speaker.
- To avoid interference, keep other wireless equipment 1 – 3 ft (0.3 – 0.9 m) away from the speaker.
- Place the speaker outside of and away from metal cabinets and direct heat sources.
- Place the speaker so that the rubber base is on a stable and level surface.
- When using *Bluetooth* technology, place your mobile device within 33 ft (10 m) of the speaker, and make sure there is a clear line of sight between you and the speaker. Moving your device farther away, or not having a clear line of sight may impact sound quality, and your device may disconnect from the speaker.

CAUTIONS:

- Stand the speaker on its base. Standing the speaker on any other side may cause damage to the speaker and affect sound quality.
- Avoid placing the speaker on wet or dirty surfaces.

The Bose Music app lets you set up and control the speaker from any mobile device such as a smartphone or tablet.

Using the app, you can stream music, set and change presets, add music services, explore internet radio stations, configure Google Assistant or Amazon Alexa, and manage speaker settings.

NOTE: If you have already created a Bose Music account in the Bose Music app for another product, see “Add the speaker to an existing account” on page 17.

DOWNLOAD THE BOSE MUSIC APP

1. On your mobile device, download the Bose Music app.



2. Follow the app instructions.

ADD THE SPEAKER TO AN EXISTING ACCOUNT

In the Bose Music app, go to the My Products screen and add your Bose Portable Home Speaker.

CONNECT TO A DIFFERENT WI-FI NETWORK

Connect to a different network if your network name or password has changed, or if you want to change or add another network.

1. On the speaker, press and hold the Volume down button — and the Play/Pause button ▷|| until the light ring glows amber on the top and bottom.
2. On your mobile device, open your Wi-Fi settings.
3. Select Bose Portable Home Speaker.
4. Open the Bose Music app and follow the app instructions.

NOTE:

- If the app doesn't prompt you for setup, go to the My Products screen and add your speaker.
- When connected to Wi-Fi, your speaker has access to voice control and all other features offered in the Bose Music app.

RECONNECT TO A WI-FI NETWORK

The speaker will automatically reconnect to a known Wi-Fi network if the speaker is powered on, and in range of the Wi-Fi network.

NOTE: The speaker stores up to 8 different Wi-Fi networks in the order they were last used.

POWER ON

Press the Power button .

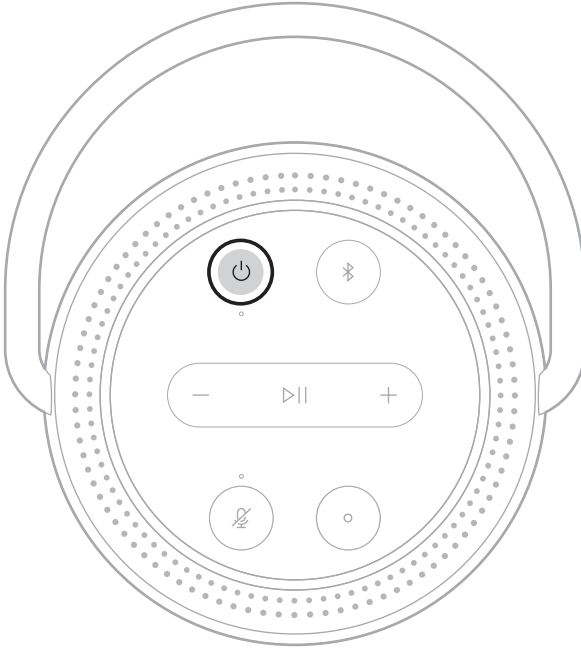

A voice prompt announces the battery level.

POWER OFF

Press and hold the Power button  until the power light turns off.

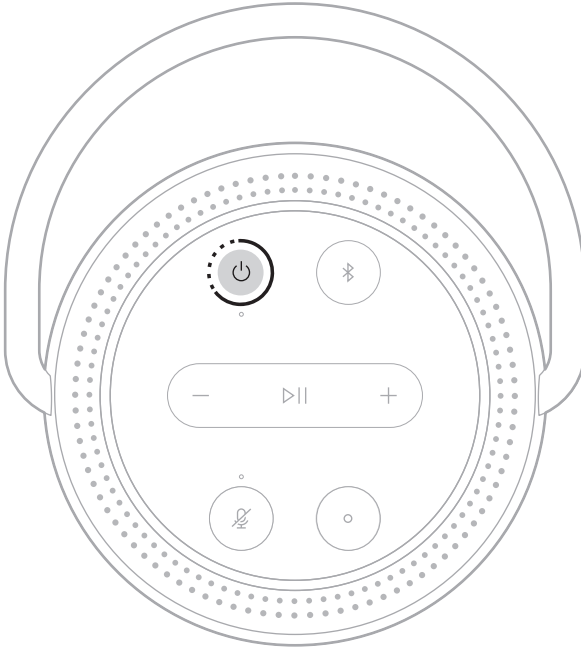

NOTES:

- If the speaker isn't connected to a Wi-Fi network, streaming audio with *Bluetooth* technology, or charging, it powers off automatically after 20 minutes of inactivity.
- If Wi-Fi hasn't been set up using the Bose Music app, press the Power button once to power off the speaker.

NETWORK STANDBY

The speaker transitions to network standby when audio has stopped and you have not pressed any buttons or accessed your voice assistant for 20 minutes.

To wake the speaker from network standby:

- Press any button on the speaker.
- Play or resume audio using your mobile device or using the Bose Music app.
- Talk to your voice assistant.

NOTE: To access your voice assistant in network standby, set it up using the Bose Music app and turn on the microphone (see page 16).

SPEAKER CONTROLS

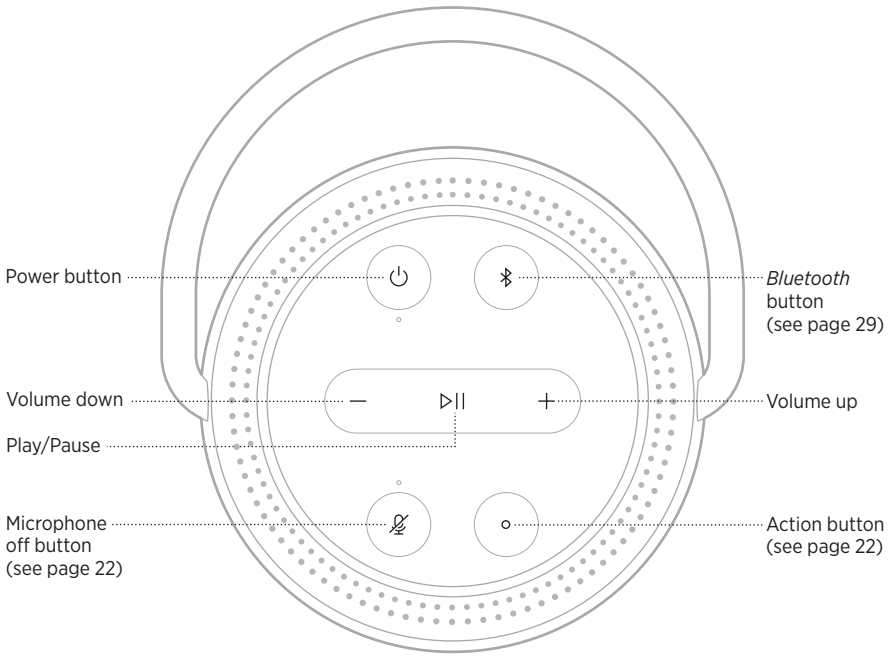

SPEAKER FUNCTIONS

Speaker controls are located on the top of the speaker.

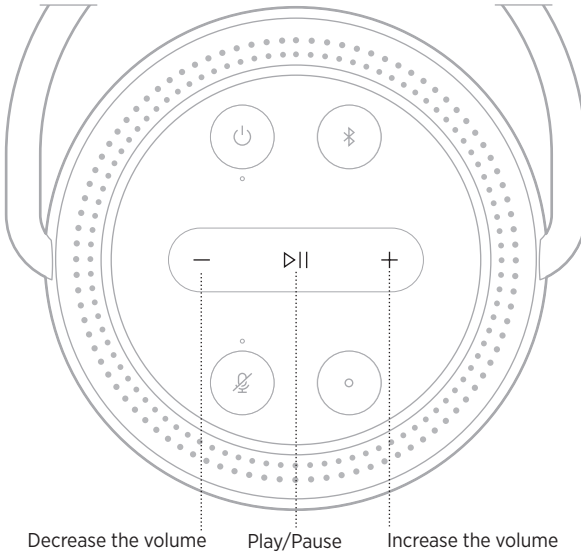

TIP: You can also control the speaker using the Bose Music app.

Media playback and volume



FUNCTION	WHAT TO DO
Play/Pause	Press ▷ . When audio is paused, two lights on the top and two lights on the bottom of the light ring glow white.
Skip forward	Double-press ▷ .
Skip backward	Triple-press ▷ .
Increase the volume	Press +. The light ring fills clockwise. NOTE: To quickly increase the volume, press and hold +.
Decrease the volume	Press -. The light ring fades counter-clockwise. NOTE: To quickly decrease the volume, press and hold -.

VOICE ASSISTANT CONTROLS

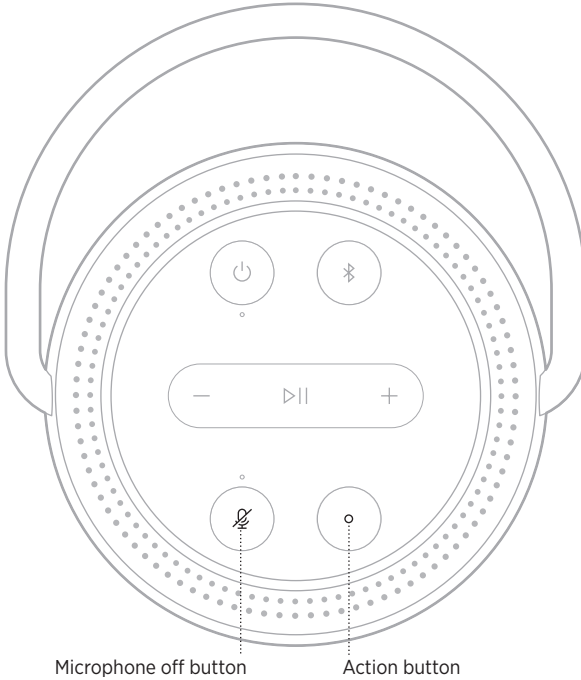

You can use the Action button  and Microphone off button  to control Google Assistant (see page 24) or Amazon Alexa (see page 27).



VOICE ASSISTANT OPTIONS

You can program the speaker to quickly and easily access Google Assistant or Amazon Alexa.

NOTE: Google Assistant and Amazon Alexa aren't available in certain languages and countries.

OPTIONS	HOW TO USE
Google Assistant	Use your voice and/or the Action button  (see page 24).
Amazon Alexa	Use your voice and/or the Action button  (see page 27).

NOTE: You can't set the speaker to access Google Assistant and Amazon Alexa at the same time.

SET UP YOUR VOICE ASSISTANT

Before you begin, make sure your mobile device and the speaker are connected to the same Wi-Fi network.

To set up your voice assistant, use the Bose Music app. You can access this option from the Settings menu.

NOTE: When setting up your voice assistant, make sure you use the same audio service account that you used in the Bose Music app.

ACCESS GOOGLE ASSISTANT

With your Bose Portable Home Speaker, talk to Google to easily enjoy music at home; you can play your favorite music, control volume and find information about the song that you are listening to, hands-free. You can also plan your day, set alarms and control smart devices around your home - just by using your voice.

For more information about what Google Assistant can do, visit:

<https://support.google.com/assistant>

NOTES:



- Google Assistant isn't available in certain languages and countries.
- For more information about playing audio with Google Assistant, see page 26.

Use your voice

Start with "Hey Google," then say:

THINGS TO TRY	EXAMPLES OF WHAT TO SAY
Enjoy entertainment	Play some music
Plan your day	What's on my calendar today?
Manage tasks	Set an alarm for 7am tomorrow
Control your home	Turn on the lights
Get answers	What's the latest news?
Get things done	Remind me to buy milk tonight
Try fun things	Tell me a fun fact



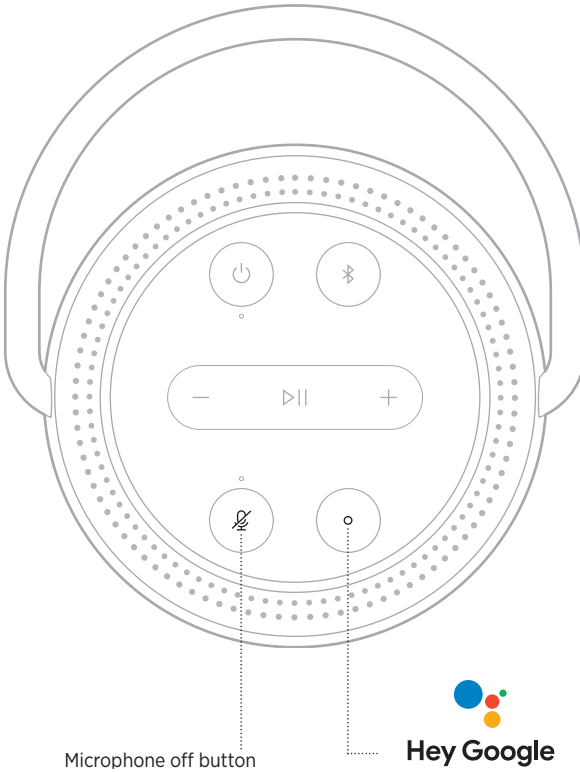

Use the speaker controls

You can use the Action button  and Microphone off button  to control Google Assistant. They are located on the top of the speaker.



THINGS TO TRY

WHAT TO DO

Talk to Google Assistant	Press  then say your request. For a list of things to try, visit: https://support.google.com/assistant
Stop alarms and timers	Press  .
Stop Google Assistant	Press  .
Turn the microphone on/off	Press  . When the microphone is off, the light above the Microphone off button  glows solid red, and you can't access Google Assistant.

PLAY MUSIC WITH GOOGLE ASSISTANT

Ask Google to play music from your default audio service or from a specific audio service.

Start with “Hey Google,” then say:

THINGS TO TRY	EXAMPLES OF WHAT TO SAY
Play music	Play some music. NOTE: Google Assistant uses your default audio service. If you hear an error message, you may need to change your default audio service. To change this setting, use the Google Assistant app.
Control your speaker	Turn up the volume.
Play from a specific audio service	Play NPR on TuneIn NOTE: Google Assistant doesn't support all audio services.
Play on a specific speaker	Play some jazz on the living room speakers NOTE: Make sure you say the speaker name you assigned in the Bose Music app. If multiple speakers have the same name, use the name assigned in the Google Assistant app or change the name in the Bose Music app.

Choose a default music service

During initial setup for Google Assistant, the Google Assistant app prompts you to select a default audio service. When asking Google to play music on Bose products, only Pandora and Spotify are supported default services. Although other audio services are listed as available during setup, they are not supported.

For the best experience, choose Pandora or Spotify as your default audio service. If you choose an unsupported audio service, you hear an error message when requesting to play audio.

ACCESS ALEXA

The speaker has Amazon Alexa Built-in. With Alexa, you can ask to play music, hear the news, check the weather, control smart home devices, and more. Using Alexa on your speaker is as simple as asking. Just ask or use the Action button  and Alexa responds instantly.

For more information about what Alexa can do, visit:



<https://www.amazon.com/usealexa>

NOTE: Alexa isn't available in certain languages and countries.

Use your voice

THINGS TO TRY	EXAMPLE OF WHAT TO SAY
Talk to Alexa	Alexa, what's the weather?
Play audio	Alexa, play Beethoven. NOTE: Amazon Music is set as the default music service. To change the default music service, use the Alexa app.
Control volume	Alexa, turn the volume up.
Play from a specific audio service	Alexa, play NPR on TuneIn. NOTE: Amazon Alexa doesn't support all audio services.
Play on a specific speaker	Alexa, play funk in the living room. NOTE: Make sure you say the speaker name you assigned in the Bose Music app. If multiple speakers have the same name, use the name assigned in the Alexa app or change the name in the Bose Music app.
Skip to the next song	Alexa, next song.
Set a timer	Alexa, set a timer for 5 minutes.
Discover more skills	Alexa, what new skills do you have?
Stop Alexa	Alexa, stop.

Use the speaker controls

The Action button  and Microphone off button  are used to control Alexa. They are located on the top of the speaker.

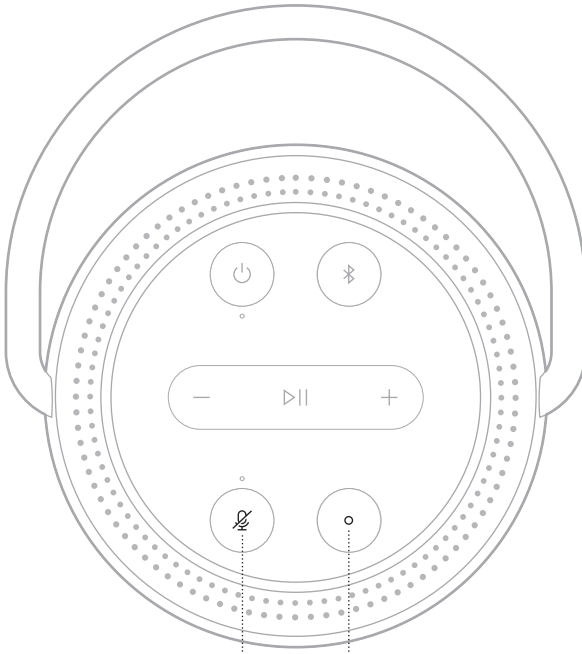





Microphone off button



THINGS TO TRY

WHAT TO DO

Talk to Alexa	Press  then say your request. For a list of things to try, visit: https://www.amazon.com/usealexa
Stop alarms and timers	Press  .
Stop Alexa	Press  .
Turn the microphone on/off	Press  . NOTE: When the microphone is off, and the light above the Microphone off button  glows solid red, you can't access Alexa.

Bluetooth wireless technology lets you stream music from mobile devices such as smartphones, tablets, and laptop computers. Before you can stream music from a device, you must connect your device to the speaker.

USING *BLUETOOTH* ONLY (NO WI-FI)

When your speaker is disconnected from Wi-Fi, you only have access to the *Bluetooth* functions of the speaker. To connect your mobile device using *Bluetooth* technology, see page 29.

NOTE: When using *Bluetooth* technology only, you don't have access to a voice assistant or the features in the Bose Music app.

CONNECT A MOBILE DEVICE

1. Press and hold the *Bluetooth* button .

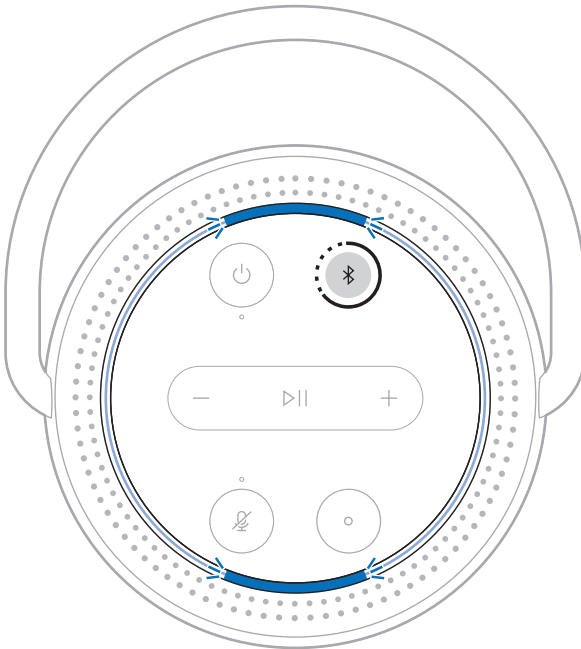

You hear a tone and the light ring pulses blue.

2. On your device, turn on the *Bluetooth* feature.

TIP: The *Bluetooth* menu is usually found in the settings menu on your mobile device.

3. Select your speaker from the device list.

TIP: Look for the name you entered for your speaker in the Bose Music app. If you didn't name your speaker, the default name appears.



Once connected, you hear a tone and the light ring glows solid blue on the top and bottom then fades to black. Your speaker's name appears in the mobile device list.

DISCONNECT A MOBILE DEVICE

Use the Bose Music app to disconnect your mobile device.

TIP: You can also use *Bluetooth* settings to disconnect your device. Disabling the *Bluetooth* feature disconnects all other devices.

RECONNECT A MOBILE DEVICE

1. Press the *Bluetooth* button .

NOTE: Make sure the *Bluetooth* feature is enabled on your mobile device.

2. Play audio on the connected mobile device.

CONNECT AN ADDITIONAL MOBILE DEVICE

You can store up to eight devices in the speaker device list.

NOTE: You can play audio from only one device at a time.

1. Press and hold  until the light bar pulses blue.
2. On your mobile device, select the speaker from the device list.

NOTE: Make sure the *Bluetooth* feature is enabled on your mobile device.

CLEAR THE SPEAKER DEVICE LIST

1. Press and hold  for 10 seconds until the light ring pulses blue twice on the top and bottom.
2. Delete the speaker from the *Bluetooth* list on your device.

All devices are cleared, and the speaker is ready to connect (see page 29).

The speaker is capable of playing AirPlay 2 audio, which allows you to quickly stream audio from your Apple device to the speaker or multiple speakers.

NOTES:

- To use AirPlay 2, you need an Apple device running iOS 11.4 or later.
- Your Apple device and speaker must be connected to the same Wi-Fi network.
- For more information about AirPlay, visit: <https://www.apple.com/airplay>

STREAM AUDIO FROM THE CONTROL CENTER

1. On your Apple device, open the Control Center.
2. Touch and hold the audio card in the top-right corner of the screen, then the AirPlay icon .
3. Select your speaker or speakers.

STREAM AUDIO FROM AN APP

1. Open a music app (like Apple Music), and select a track to play.
2. Tap .
3. Select your speaker or speakers.

CHARGE THE SPEAKER

1. Connect the power cord to the power port on the speaker.

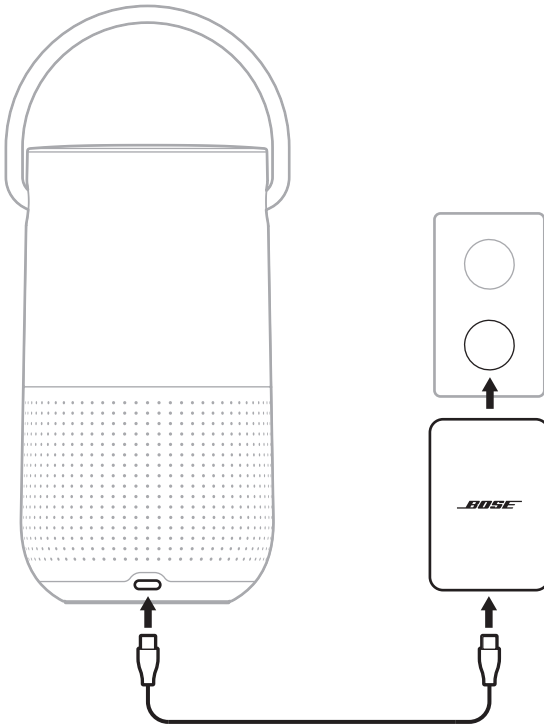

2. Connect the power cord to the power adapter.
3. Plug the power adapter into an AC (mains) power outlet.
The speaker powers on and the power light starts to blink white.

Charge the speaker using the Bose Portable Home Speaker Charging Cradle

You can charge the speaker on the Bose Portable Home Speaker Charging Cradle. To purchase the charging cradle, contact your authorized Bose dealer.

Visit: worldwide.Bose.com/Support/PHS

CHECK THE BATTERY LEVEL

Press the Power button  when the speaker is on and not playing audio.

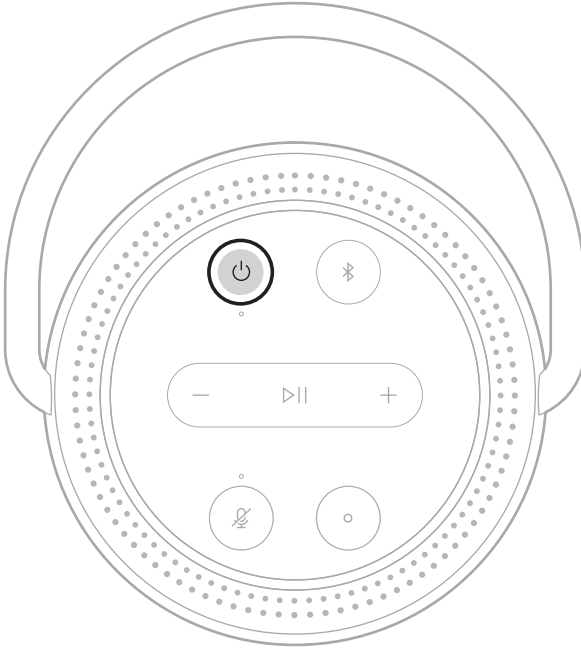

A voice prompt announces the battery level.

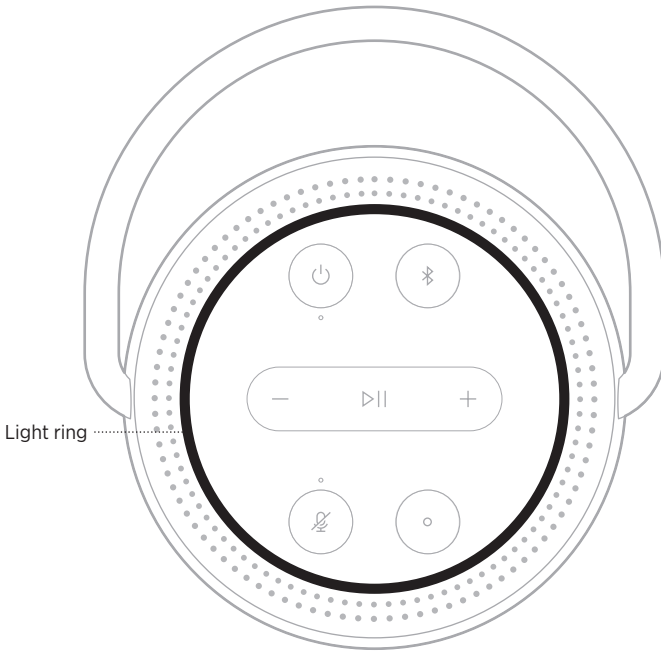

TIP: You can also check the battery level using the Bose Music app.

The LED light ring located on the top of the speaker shows the speaker status.





WI-FI STATUS

Shows the Wi-Fi connection status of the speaker.

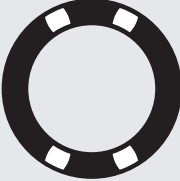

LIGHT RING ACTIVITY	SYSTEM STATE
<p>Pulsing white on top and bottom</p> 	<p>Connecting to Wi-Fi</p>
<p>Solid white then fades to black on top and bottom</p> 	<p>Connected to Wi-Fi</p>

MEDIA PLAYBACK AND VOLUME STATUS

LIGHT RING ACTIVITY	SYSTEM STATE
<p data-bbox="97 331 298 402">Two lights on the top and two lights on the bottom glow white</p> 	<p data-bbox="751 355 875 378">Paused audio</p>
<p data-bbox="97 544 231 591">White light fills clockwise</p> 	<p data-bbox="751 557 902 579">Increase volume</p>
<p data-bbox="97 743 274 790">White light fades counter-clockwise</p> 	<p data-bbox="751 756 910 779">Decrease volume</p>

BLUETOOTH CONNECTION STATUS

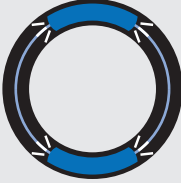



Shows the *Bluetooth* connection status for mobile devices.

LIGHT RING ACTIVITY	SYSTEM STATE
<p>Pulsing blue on top and bottom</p> 	<p>Ready to connect to mobile device</p>
<p>Blinks blue on top and bottom</p> 	<p>Connecting to mobile device</p>
<p>Solid blue then fades to black on top and bottom</p> 	<p>Connected to mobile device</p>
<p>Blinks blue twice</p> 	<p>Clearing device list</p>



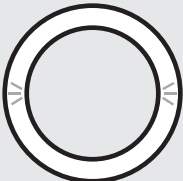

VOICE ASSISTANT STATUS

Shows the status of Google Assistant or Amazon Alexa.

Google Assistant status

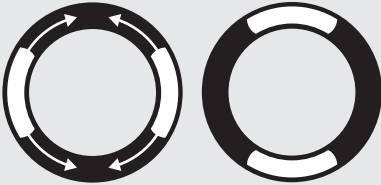
LIGHT RING ACTIVITY	VOICE ASSISTANT STATE
<p>Off</p> 	<p>Idle</p>
<p>White light on top, bottom, left, and right</p> 	<p>Listening</p>
<p>White light rotates clockwise</p> 	<p>Thinking</p>
<p>Pulsing white (full)</p> 	<p>Speaking</p>
<p>White light blinks for 10 minutes</p> 	<p>Notification</p>

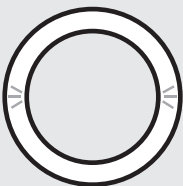
Amazon Alexa status

LIGHT RING ACTIVITY		VOICE ASSISTANT STATE
Off		Idle
White light slides to the top and bottom		Listening
Solid white light glows on top and bottom		Thinking
Pulsing white (full)		Speaking
Pulsing yellow on top and bottom		Notification

Microphone off light

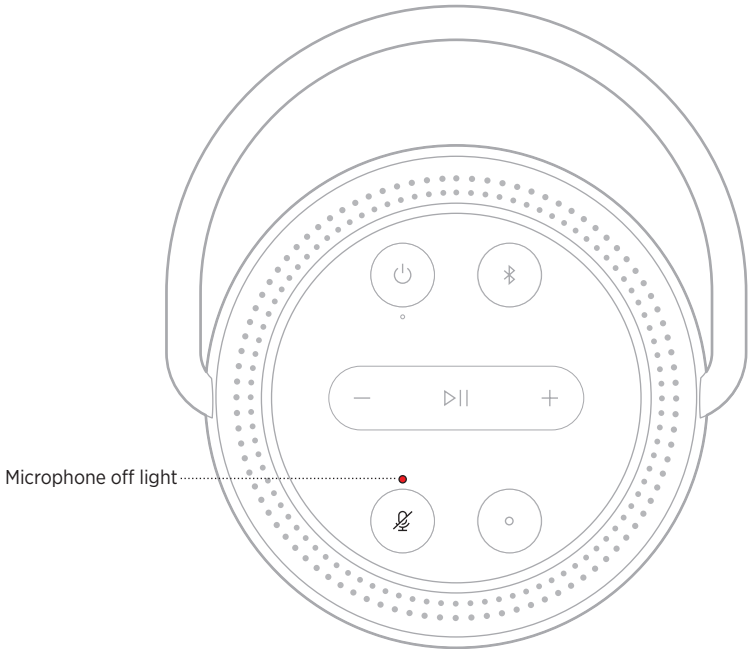

LIGHT ACTIVITY

SYSTEM STATE

Solid red

Microphone is off



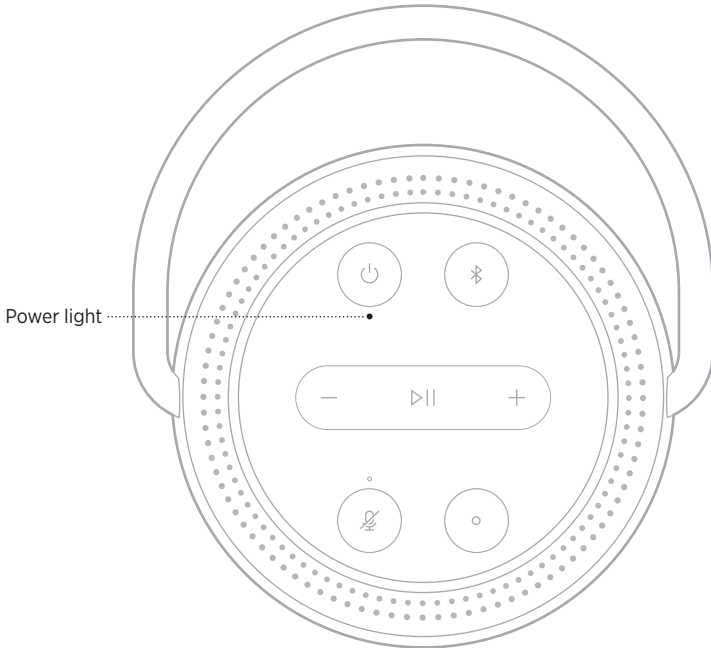

POWER STATUS



LIGHT ACTIVITY	SYSTEM STATE
Solid white	On NOTE: When the speaker is connected to the charging cable solid whites means full charge.
Blinking white	Charging
Dim white	Network standby NOTE: The speaker only shows dim white light when it isn't charging.
Solid red	5% - 10% battery remaining
Blinking Red	Less than 5% battery remaining
Black	Off

UPDATE AND ERROR STATUS

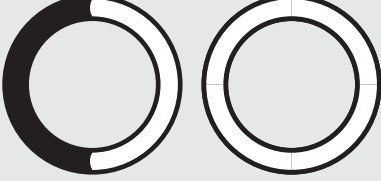
Shows the status of the software updates and error alerts.

LIGHT RING ACTIVITY	SYSTEM STATE
<p data-bbox="96 375 280 423">Solid amber on top and bottom</p> 	<p data-bbox="733 386 948 410">Wi-Fi setup in progress</p>
<p data-bbox="96 557 280 651">White light fills the ring counter-clockwise until full, then repeats</p> 	<p data-bbox="733 591 926 615">Downloading update</p>
<p data-bbox="96 760 272 854">White light fills the ring clockwise until full, then repeats</p> 	<p data-bbox="733 797 896 821">Updating speaker</p>
<p data-bbox="96 976 285 1040">Blinks amber on the top and bottom four times</p> 	<p data-bbox="733 984 902 1032">Error - refer to the Bose Music app</p>
<p data-bbox="96 1187 285 1227">Solid red on the top and bottom</p> 	<p data-bbox="733 1187 919 1235">Error - contact Bose customer service</p>

UPDATE THE SPEAKER

The speaker updates automatically when connected to the Bose Music app and to your Wi-Fi network.

DISABLE/ENABLE WI-FI

Press and hold Play/Pause ▶|| and the *Bluetooth* button ⌘ for 5 seconds until the light ring fills with white light.

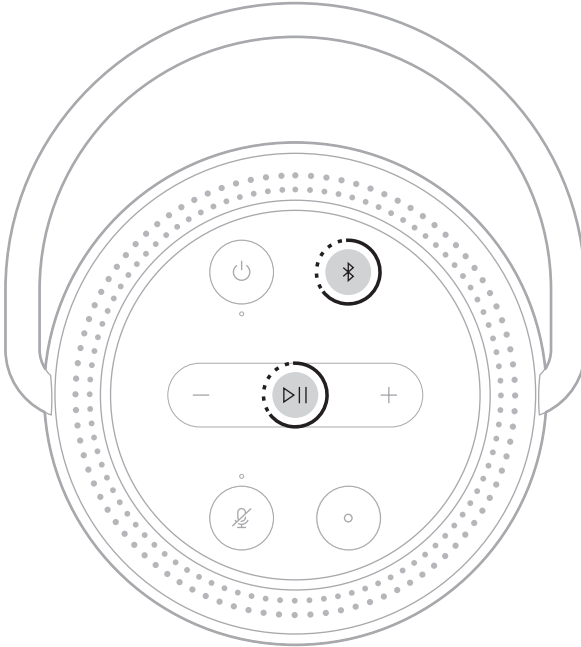

NOTE: When Wi-Fi is disabled, you can't use the Bose Music app or your voice assistant to control the speaker.

CONNECT A BOSE SOUNDLINK *BLUETOOTH* SPEAKER OR BOSE HEADPHONES

With Bose SimpleSync technology, you can connect certain Bose SoundLink *Bluetooth* speakers or Bose headphones to your Bose Portable Home Speaker for a new way to hear your music.

Benefits

- **Another room of audio:** Listen to the same song in two different rooms at the same time by connecting your Bose SoundLink *Bluetooth* speaker to your Bose Portable Home Speaker.
- **A personal listening experience:** Hear your music clearly from the next room by connecting your Bose headphones to your Bose Portable Home Speaker. Use independent volume controls on each product to lower or mute your speaker while you listen on your headphones around your home.

NOTE: SimpleSync technology has a *Bluetooth* range of 30 ft (9 m). Walls and construction materials can affect reception.

Compatible products

You can connect most Bose SoundLink *Bluetooth* speakers and select Bose headphones to your Bose Portable Home Speaker.

Popular compatible products include:

- Bose SoundLink Revolve+ *Bluetooth* speaker
- Bose SoundLink Mini *Bluetooth* speaker
- Bose SoundLink Color *Bluetooth* speaker
- Bose Noise Cancelling Headphones 700
- Bose QuietComfort 35 wireless headphones

New products are added periodically. For a complete list and more information, visit: [worldwide.bose.com/Support/Groups](https://www.worldwide.bose.com/Support/Groups)

Connect using the Bose Music app

Use the Bose Music app to connect your Bose SoundLink *Bluetooth* speaker or Bose headphones to your Bose Portable Home Speaker. For more information, visit: worldwide.bose.com/Support/Groups

NOTES:

- Make sure that the product you're connecting to is powered on, within 30 ft (9 m) of your Bose Portable Home Speaker, and ready to connect to another device. For more information, refer to your product owner's guide.
- You can connect only one product at a time to your Bose Portable Home Speaker.

RECONNECT A BOSE SOUNDLINK *BLUETOOTH* SPEAKER OR BOSE HEADPHONES

Power on your Bose SoundLink *Bluetooth* speaker or Bose headphones.

Your speaker or headphones try to connect to the most recently-connected *Bluetooth* device, including your Bose Portable Home Speaker.

NOTES:

- Your Bose Portable Home Speaker must be within range (30 ft or 9 m) and powered on.
- If your speaker or headphones don't connect, see "Speaker doesn't reconnect to a previously-connected Bose SoundLink *Bluetooth* speaker or Bose headphones" on page 51.

CLEAN THE SPEAKER

Clean the surface of the speaker with a soft, dry cloth.

CAUTIONS:

- Do NOT use any sprays near the speaker. Do NOT use any solvents, chemicals, or cleaning solutions containing alcohol, ammonia, or abrasives.
- Do NOT allow liquids to spill into any openings.

REPLACEMENT PARTS AND ACCESSORIES

Replacement parts and accessories can be ordered through Bose customer service.

Visit: worldwide.bose.com/Support/PHS

LIMITED WARRANTY

The speaker is covered by a limited warranty. Visit our website at global.bose.com/warranty for details of the limited warranty.

To register your product, visit global.bose.com/register for instructions. Failure to register will not affect your limited warranty rights.

TRY THESE SOLUTIONS FIRST

If you experience problems with the speaker, try these solutions first:

- Power on the speaker (see page 34).
- Charge the speaker (see page 16).
- Secure all cables.
- Verify the state of the speaker (see page 35).
- Download the Bose Music app and run available software updates.
- Move the speaker and mobile device away from possible interference (wireless routers, cordless phones, televisions, microwaves, etc.).
- Move the speaker within the recommended range of your wireless router or mobile device for proper operation.

OTHER SOLUTIONS



If you could not resolve your issue, see the table below to identify symptoms and solutions to common problems. If you are unable to resolve your issue, contact Bose customer service.

Visit: worldwide.Bose.com/contact

SYMPTOM	SOLUTION
Speaker doesn't power on	<p>Battery may be in protection mode or discharged. Connect your speaker to the power cord.</p> <p>Plug the power cord into a different AC (mains) outlet.</p> <p>Unplug the power cord, wait 30 seconds, and firmly plug it back in to the AC (mains) outlet.</p>
Speaker doesn't power off	<p>If Wi-Fi has been set up using the Bose Music app, press and hold the Power button until the power light has turned off.</p> <p>If Wi-Fi hasn't been set up using the Bose Music app, press the Power button once to power off the speaker.</p>
Speaker doesn't respond during setup	<p>Make sure you are using the Bose Music app for setup.</p> <p>NOTE: If the app doesn't prompt you for setup, go to the My Products screen and add your speaker.</p> <p>Unplug the power cord, wait 30 seconds, and firmly plug it back in to the AC (mains) outlet.</p>

SYMPTOM	SOLUTION
Bose Music app doesn't work on mobile device	<p>Make sure your mobile device is compatible with the Bose Music app and meets minimum system requirements. For more information, refer to the app store on your mobile device.</p> <p>Uninstall the Bose Music app on your mobile device then reinstall the app (see page 16).</p>
Speaker doesn't connect to Wi-Fi network	<p>In the Bose Music app, select the correct network name and enter the network password.</p> <p>Make sure you connect the speaker to the same Wi-Fi network your mobile device is connected to.</p> <p>If your Wi-Fi network information has changed, see page 17.</p> <p>Enable Wi-Fi on the device you are using for setup.</p> <p>Close other open applications on your mobile device.</p> <p>If your router supports both 2.4GHz and 5GHz bands, make sure both your mobile device and the speaker are connecting to the same band.</p> <p>NOTE: Bose recommends giving each band a unique name to make sure you're connecting to the correct band.</p> <p>Reset the router.</p> <p>Uninstall the Bose Music app on your mobile device. Unplug the power cord, wait 30 seconds, and firmly plug it into the AC (mains) outlet. Download the Bose Music app and restart setup.</p>
Intermittent or no audio	<p>Increase the volume on the speaker and mobile device.</p> <p>Stop other audio or video streaming applications.</p> <p>Switch to a different source.</p> <p>Play audio from a different application or music service.</p> <p>Make sure you're using a compatible <i>Bluetooth</i> mobile device.</p> <p>Restart your mobile device.</p> <p>Unplug the power cord, wait 30 seconds, and firmly plug it back in to the AC (mains) outlet.</p> <p>Make sure your speaker isn't muted. Unmute by pressing Volume up + or Volume down — on the speaker, or by using the Bose Music app.</p>

SYMPTOM	SOLUTION
<p>Speaker doesn't connect to a mobile device</p>	<p>On your mobile device, turn the <i>Bluetooth</i> feature off and then on again. Remove the speaker from the <i>Bluetooth</i> menu. Connect again.</p> <p>Connect a different mobile device (see page 29).</p> <p>Make sure you're using a compatible <i>Bluetooth</i> mobile device.</p> <p>Remove the speaker from your mobile device <i>Bluetooth</i> list. Connect again (see page 30).</p> <p>Clear the speaker device list (see page 31).</p>
<p>Speaker doesn't stream audio using AirPlay</p>	<p>Make sure your speaker is powered on and in range (see page 34).</p> <p>Update your Apple device and speaker.</p> <p>Make sure your Apple device and your speaker are connected to the same Wi-Fi network.</p> <p>Make sure the speaker is up-to-date (see page 43).</p> <p>If you can't find the AirPlay icon  in the music app you are streaming from, stream audio from the Control Center.</p> <p>For additional support, visit: https://www.apple.com/airplay</p>
<p>Speaker isn't visible to add to another Bose account</p>	<p>Make sure sharing is enabled on the speaker using the Bose Music app.</p> <p>Make sure the speaker and your mobile device are connected to the same Wi-Fi network.</p>

SYMPTOM	SOLUTION
<p>Google Assistant doesn't respond or play audio</p>	<p>Make sure Google Assistant has been set up using the Bose Music app (see page 23).</p> <p>Connect your mobile device to Wi-Fi.</p> <p>Make sure you're in a country where Google Assistant is available on this product.</p> <p>Make sure you are using the most up-to-date version of the Google Assistant app.</p> <p>Make sure the wake word is enabled (see page 24).</p> <p>Make sure your mobile device is compatible.</p> <p>Remove Google Assistant from the speaker using the Bose Music app. Then, add Google Assistant again.</p> <p>Choose Pandora or Spotify as your default audio service (see page 26).</p> <p>Make sure you use the same audio service account on the Bose Music app and Google Assistant app.</p> <p>Google Assistant may not support your request. New features are added periodically.</p> <p>For additional support, visit: https://support.google.com/assistant</p>
<p>Change Google Assistant personal result setting</p>	<p>To turn off personal results or change the account for personal results, use the Settings menu in the Google Assistant app.</p>
<p>Alexa doesn't respond</p>	<p>Make sure Alexa has been set up using the Bose Music app (see page 16).</p> <p>NOTE: The speaker must be set up and connected to your Wi-Fi network using the Bose Music app.</p> <p>Make sure you're in a country where Alexa is available on this product.</p> <p>Make sure the light above the Microphone off button  is not glowing red. Press  to turn on the microphone.</p> <p>Make sure you say the name you assigned in the Bose Music app. If multiple speakers have the same name, use the name assigned in the Alexa app or change the name in the Bose Music app.</p> <p>Remove Alexa from the speaker using the Bose Music app, then add Alexa again.</p> <p>Alexa may not support your request. New features are added periodically.</p> <p>For additional support, visit: https://www.amazon.com/usealexa</p>

SYMPTOM	SOLUTION
<p>Speaker doesn't connect to a Bose SoundLink <i>Bluetooth</i> speaker or Bose headphones</p>	<p>Make sure that your Bose SoundLink <i>Bluetooth</i> speaker or headphones are powered on, within 30 ft (9 m) of your Bose Portable Home Speaker, and ready to connect to another device. For more information, refer to your product owner's guide.</p>
<p>Speaker doesn't reconnect to a previously-connected Bose SoundLink <i>Bluetooth</i> speaker or Bose headphones</p>	<p>On your Bose SoundLink <i>Bluetooth</i> speaker or headphones, use the product controls to cycle through the product device list until you hear the name for your Bose Portable Home Speaker. For product-specific instructions, refer to your product owner's guide.</p> <p>NOTE: Certain speakers and headphones, including Bose Noise Cancelling Headphones 700, don't support the ability to cycle through the product device list. To reconnect those products, see "Connect using the Bose Music app" on page 45.</p>
<p>Delayed audio from a connected Bose SoundLink <i>Bluetooth</i> speaker or Bose headphones</p>	<p>Not all Bose SoundLink <i>Bluetooth</i> speakers and headphones can play audio in perfect sync when connected to the speaker. To check if your product is compatible, visit: worldwide.Bose.com/Support/Groups</p> <p>Install any available software updates for your Bose SoundLink <i>Bluetooth</i> speaker or headphones. To check for updates, open the appropriate Bose app for your product on your mobile device or visit btu.Bose.com on your computer.</p>

RESET THE SPEAKER

Factory reset clears all source, volume, and network settings from the speaker and returns it to original factory settings.

Press and hold the Volume up button + and the *Bluetooth* button ⌘ for 10 seconds until the light ring fills with white light.

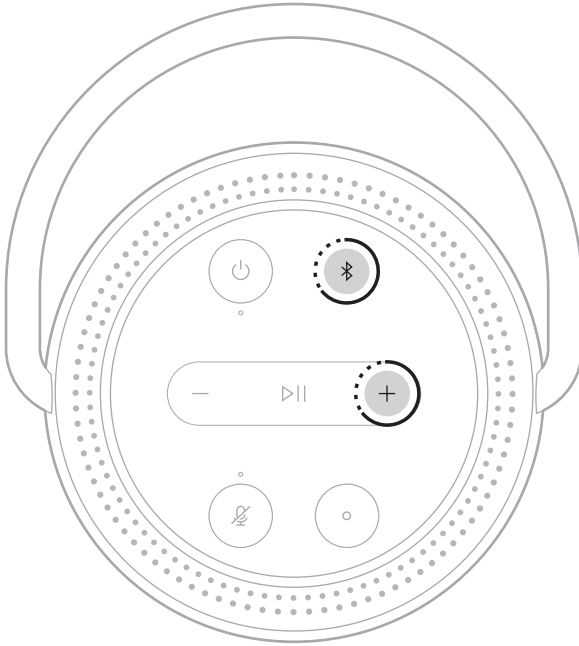

The speaker reboots. When the reset is complete, the light ring glows solid amber.

Restore the speaker network and audio settings

Set up the speaker using the Bose Music app (see page 16).



837954-0010